

SEMOKii , An MPMC Brand



Portable
Power Stations



Residential Energy
Storage Solutions



Lithium
Battery Packs

USER MANUAL EHOO INVERTER



MPMC USA



MPMC UK



MPMC UAE



MPMC ZA



MPMC CN

SEMOKII BESS CO., LTD.

📍 No.2399 Fazhan Ave., Haimen Port New Area, Jiangsu 226156, China.

☎ +86-15000854420

✉ sales@semookii.com

🌐 www.semookii.com www.semookii.jp

www.semookii.de

SEMOKii-2023© All rights reserved

Copyright Declaration

The copyright of this manual belongs to SEMOOKII BESS CO., LTD. Any corporation or individual should not plagiarize, partially or fully copy (including software, etc.), and no reproduction or distribution of it in any form or by any means. All rights reserved. SEMOOKII BESS CO., LTD. reserves the right of final interpretation.

CHANGE HISTORY

Changes between document versions are cumulative. The latest version contains all updates made in previous versions.

Version 05 (Feb. 11, 2023)

Replace sensitive words

Version 04 (Feb. 03, 2023)

Added Change History

Updated 4 Technical Data (Modified and added new items)

Version 03 (Sep. 25, 2022)

Modified the external meter wiring diagram

Modified earth torque, AC short circuit breaker current

Modified the fault list, MLPE terminal diagram and mode

Version 02 (Aug. 02, 2022)

Modified machine diagram and indicators

Deleted 2030.5, etc.

Version 01 (May 25, 2022)

Modified installation methods, indicators, and faults

Version 00 (Oct. 22, 2021)

Initial release

TABLE OF CONTENTS

1	NOTE ON THIS MANUAL.....	1
1.1	SCOPE OF VALIDITY.....	1
1.2	TARGET GROUP.....	1
1.3	SYMBOLS USED.....	1
2	SAFETY.....	3
2.1	IMPORTANT SAFETY INSTRUCTIONS.....	3
2.2	EXPLANATION OF SYMBOLS.....	8
3	INTRODUCTION.....	9
3.1	SYSTEM.....	9
3.2	WORK MODES.....	12
3.3	DIMENSIONS.....	15
3.4	OVERVIEW OF THE INVERTER.....	15
3.5	EXTERNAL TERMINALS OF INVERTER.....	16
3.6	INTERNAL TERMINALS IN WIRING BOX.....	17
3.7	IDENTIFICATION OF EHO0-HYBRID SERIES.....	18..
4	TECHNICAL DATA.....	19
4.1	DC INPUT.....	19
4.2	AC LOAD.....	19
4.3	GENERAL DATA.....	19
4.4	BATTERY / INPUT / OUTPUT	20
4.5	EFFICIENCY, SAFETY AND PROTECTION.....	20
4.6	ENVIRONMENT LIMIT.....	20
5	MECHANICAL INSTALLATION.....	21
5.1	INSTALLATION PRECAUTION.....	21
5.2	SELECTION FOR INSTALLATION POSITION.....	22
5.3	TOOLS PREPARATION.....	25
5.4	CHECK FOR TRANSPORT DAMAGES.....	26
5.5	PACKING LISTS.....	26
5.6	INSTALLATION STEPS.....	28
6	ELECTRICAL CONNECTION.....	36
6.1	OVERVIEW OF ALL ELECTRICAL WIRING METHODS.....	37
6.2	POWER CONNECTION.....	42
6.3	GROUND CONNECTION.....	50
6.4	COMMUNICATION CONNECTION.....	52

7	INVERTER OPERATION METHOD.....	63
7.1	CHECK BEFORE TURN ON THE SYSTEM.....	63
7.2	TURN ON THE SYSTEM.....	63
7.3	SHUT DOWN THE SYSTEM.....	64
7.4	DEFINITION OF INDICATOR LIGHT AND BUTTON.....	64
8	FIRMWARE UPGRADING.....	66
8.1	PREPARATION.....	66
8.2	UPGRADING STEPS.....	66
9	TROUBLESHOOTING.....	68
10	MAINTENANCE.....	73
11	DECOMMISSIONING.....	74
11.1	TROUBLE SHOOTING.....	74
11.2	ROUTINE MAINTENANCE.....	74
11.3	STORAGE AND TRANSPORTATION.....	74
11.4	DISPOSAL OF INVERTER.....	74
12	DISCLAIMER.....	75
*	APPENDIX A: EPO CONNECTION STEPS	
*	APPENDIX B: METER Y CONNECTION STEPS	
*	APPENDIX C: SYSTEM WIRING DIAGRAM	
*	WARRANTY REGISTRATION FORM	

1 Note on this Manual

1.1 Scope of Validity

This manual is an integral part of the EHOO-HYBRID / EHOO-AC COUPLED / EHOO-SOLAR series inverter. It describes the assembly, installation, commissioning, maintenance and failure of the product. Please read it carefully before operating.

EHOO-HYBRID

EHOO-HYBRID-3.8 | EHOO-HYBRID-5.0 | EHOO-HYBRID-6.0 | EHOO-HYBRID-7.6

EHOO-AC COUPLED

EHOO-AC COUPLED-3.8 | EHOO-AC COUPLED-5.0 | EHOO-AC COUPLED-6.0 | EHOO-AC COUPLED-7.6

EHOO-SOLAR

EHOO-SOLAR-3.8 | EHOO-SOLAR-5.0 | EHOO-SOLAR-6.0 | EHOO-SOLAR-7.6

Note: “EHOO-HYBRID” series means PV grid-supported storage inverter. “EHOO-AC COUPLED” series means energy storage inverter. There may be no solar module connected to inverter, and the PV power option will be deactivated. “EHOO-SOLAR” series means PV grid-supported inverter. No battery is connected to the inverters and the battery option will be deactivated.

“3.8K” means 3.8 kW.

The assembly, installation, commissioning and maintenance in this manual will take EHOO-HYBRID series inverter as an example.

Store this manual where it will be accessible at all times.



WARNING!

Save these instructions-This manual contains important instructions that shall be followed during installation and maintenance of the unit.

1.2 Target Group

This manual is for qualified electricians. The tasks described in this manual should only be performed by qualified electricians.

1.3 Symbols Used

The following types of safety instructions and general information appearing in this document are described below:

**WARNING!**

These servicing instructions are for the use by qualified personnel only. To reduce the risk of electric shock, do not perform any servicing other than that specified in the operating instructions unless you are qualified to do so.

**DANGER!**

“Danger” indicates a hazardous situation which, if not avoided, will result in serious injury or death.

**WARNING!**

“Warning” indicates a hazardous situation which, if not avoided, could result in serious injury or death.

**CAUTION!**

“Caution” indicates a hazardous situation which, if not avoided, could result in minor to moderate injury.

**NOTE!**

“Note” provides tips for the optimal operation of our product.

2 Safety

2.1 General Safety Instructions

This manual contains important instructions for EHOO-HYBRID series inverter that should be followed during installation and maintenance for the inverter.

EHOO-HYBRID series inverter is designed and tested to meet all applicable North American and International safety standards. However, like all electrical and electronic equipment, safety precautions must be observed and followed during installation and operation of the EHOO-HYBRID series inverter to reduce the risk of personal injury and to ensure a safe installation.

Installation, commissioning, service, and maintenance of EHOO-HYBRID series inverter must only be performed by authorized personnel that are licensed and/or satisfy state and local jurisdiction regulations.

Before starting installation or commissioning, read the entire manual carefully to ensure correct and safe installation or commissioning.

All US electrical installations must comply and be in accordance with all the state, local, utility regulations, and National Electrical Code ANSI/NFPA 70.

**WARNING!**

This document does not replace and is not intended to replace any local, state, provincial, including without limitation applicable in the jurisdiction of installation. SEMOOKII assumes no responsibility for the compliance or non-compliance with such laws or codes in connection with the installation of the product.

**DANGER!**

Danger to life due to high voltages in the inverter!
Before connecting the product to the electrical utility grid, contact the local utility company.
Children should be supervised to ensure that they do not play with the appliance.

**WARNING!**

Do not operate the inverter when the device is running.

**WARNING!**

Risk of electric shock!

**WARNING!**

When handling battery, adhere to all manufacturer safety instructions!

**WARNING!**

Only accessories shipped with the inverter are recommended for use. Using other accessories may result in a fire or injury to the user.

**WARNING!**

Do not disassemble any parts of the inverter which are not mentioned in the installation guide. It contains no user-serviceable parts. See warranty for instructions on obtaining service. Attempting to service the inverter yourself may result in a risk of electric shock or fire and will void your warranty.

**WARNING!**

The inverter input and output circuits are isolated from the enclosure. This system does not include an isolation transformer and should be installed with an ungrounded PV array in accordance with the requirements of ANSI/NFPA 70, NEC 690.41. Equipment grounding is the responsibility of the installer and must be performed in accordance with all applicable Local and National Codes.

**WARNING!**

Before operating the inverter, ensure that the inverter is grounded properly. This product must be connected to a grounded, metal, permanent wiring system, or an equipment-grounding conductor must be run with the circuit conductors and connected to the equipment grounding terminal or lead on the product.

**WARNING!**

When a ground fault is indicated, normally grounded conductors may be ungrounded and energized or normally ungrounded conductors may be grounded.

**WARNING!**

Keep away from flammable and explosive materials to avoid fire. Do not install or store the system in a corrosive environment where it may be exposed to ammonia, corrosive gases, acids, or salts (e.g.: chemical plant, fertilizer storage areas, tanneries, near volcanic ash eruption).

**WARNING!**

Neither touch the positive nor the negative pole of the PV connecting device. Never touch both poles at the same time.

**CAUTION!**

EHOO-HYBRID series inverter only supports a certain type of lithium-ion battery! (Manufacturer certified battery)

**CAUTION!**

Possible damage to health as a result of the effects of radiation! Do not stay closer than 7.87 in/20 cm to inverter for a long time.

**CAUTION!**

Danger of burn injuries due to hot enclosure parts! During operation, the enclosure may become hot.

**CAUTION!**

Risk of electric shock from energy stored in the capacitor. Never operate on the inverter couplers, the Mains cables, battery cables and PV cables when power is applied. After switching off the PV, battery and Mains, always wait for 5 minutes to fully discharge the intermediate circuit capacitors before unplugging DC, battery and Mains couplers.

**CAUTION!**

The unit contains capacitors that remain charged to a potentially lethal voltage after the MAINS, battery and PV supply have been disconnected. Hazardous voltage will be present for up to 5 minutes after disconnection from the power supply.

**CAUTION!**

When accessing the internal circuit of the inverter, it is very important to wait 5 minutes before operating the power circuit or demounting the electrolyte capacitors inside the device. Do not open the device beforehand since the capacitors require time to sufficiently discharge!

**CAUTION!**

Use insulated tools when installing the device. Individual protective tools must be worn during installation, electrical connection and maintenance.

**NOTE!**

The inverter is heavy. Use of lift equipment is recommended.

**NOTE!**

Make sure that existing wiring is in good condition and that wire is not undersized.

**NOTE!**

Measure the voltage between terminals UDC+ and UDC- with a multi-meter (impedance at least 1Mohm) to ensure that the device is discharged before working (35VDC) inside the device.

► **Lightning and surge protection**

EHO0-HYBRID series inverter is designed and certified to meet stringent UL1741 / IEEE 1547 and ANSI / IEEE 62.41 / 62.42 lightning and surge requirements. However, every PV installation is unique. Additional external UL / NEC AC and DC surge protection and solid grounding practices are recommended.

► **Battery safety instructions**

EHO0-HYBRID Series inverter should be coupled with a high voltage battery. The battery must comply with UL 1973 and must be intrinsically safe.





As accumulator batteries may contain potential electric shock and short-circuit current dangers, the following warnings should be observed during battery replacement to avoid accidents that might be thus resulted:

- Do not wear watches, rings or similar metallic items.
- Use insulated tools.
- Put on rubber shoes and gloves.
- Do not place metallic tools and similar metallic parts on the batteries.
- Switch off loads connected to the batteries before dismantling battery connection terminals.
- Only personnel with proper expertise should carry out the maintenance of accumulator batteries.

2.2 Explanation of Symbols

This section gives an explanation of all the symbols shown on the inverter and on the label.







► Indicator lights on the Inverter

Symbol	Explanation
	Operation indicator light
	Battery indicator light
	Fault indicator light 2
	Fault indicator light 1

► Symbol on the Inverter

Symbol	Explanation
	Equipment grounding conductor (PE)

► Symbols on the Label

Symbol	Explanation
	CSA certified.
	Type 1 Arc-Fault Circuit-interrupter on PV side
	Beware of hot surface. The inverter will become hot during operation. Avoid any contact during operation.
	Danger of high voltages. Danger to life due to high voltages in the inverter!
	Read the enclosed documents.
	Danger to life due to high voltage. There is residual voltage existing in the inverter after powering off, which needs 5 minutes to discharge. Wait 5 minutes before opening the upper lid or the DC lid.

3 Introduction

3.1 System

EHO0-HYBRID series inverter is transformerless type without galvanic isolation. It is designed and certified to fulfill the directives of ANSI/NFPA 70, NEC 690.41, UL 1741, UL 1741 SA, IEEE 1547 and IEEE 1547.1. The inverter converts the DC power generated by PV strings into AC power and stores the energy into the battery bank or feeds the power into the power grid.

With the device, you have acquired the system that can be used to power critical loads during a grid outage by using a battery and realize automatic transfer from grid connection mode to off grid mode or from off grid mode to grid connection model by using backup interface (BI). In addition, the inverter also has the ability to use power generated from PV arrays along with other string inverter.

EHO0-HYBRID series

The EHO0-HYBRID series inverter manages battery and system energy.

PV Array

The PV array works in MPPT mode. For 3.8 kW, 5.0 kW and 6.0 kW inverter, the number of PV string is two. For 7.6 kW inverter, the number of PV string is three.

RSD

The RSD provides an automatic disconnect of residential or small commercial PV systems, fully compliant with the rapid shutdown requirements of National Electric Code (NEC), ANSI/NFPA 70 Sections 690.12.

Battery (Optional)

The EHO0-HYBRID series inverter should be coupled a high voltage battery. The battery communicate with inverter via BMS and must comply with the specification of UL 1973.

Backup Interface (Optional)

The backup interface supports multi-inverter parallel connection, controls disconnection of house loads from the grid in case of a power outage and integrates the energy meter, microgrid interconnection device and generator to enable grid-tied solar backup.

SEMOOKII Cloud

SEMOOKII Cloud is an intelligent, multifunctional monitoring platform that can be accessed either remotely or through a hard wired connection. With the SEMOOKII Cloud, the operators and installers can always view key and up to date data.

System overview of EHOO-HYBRID

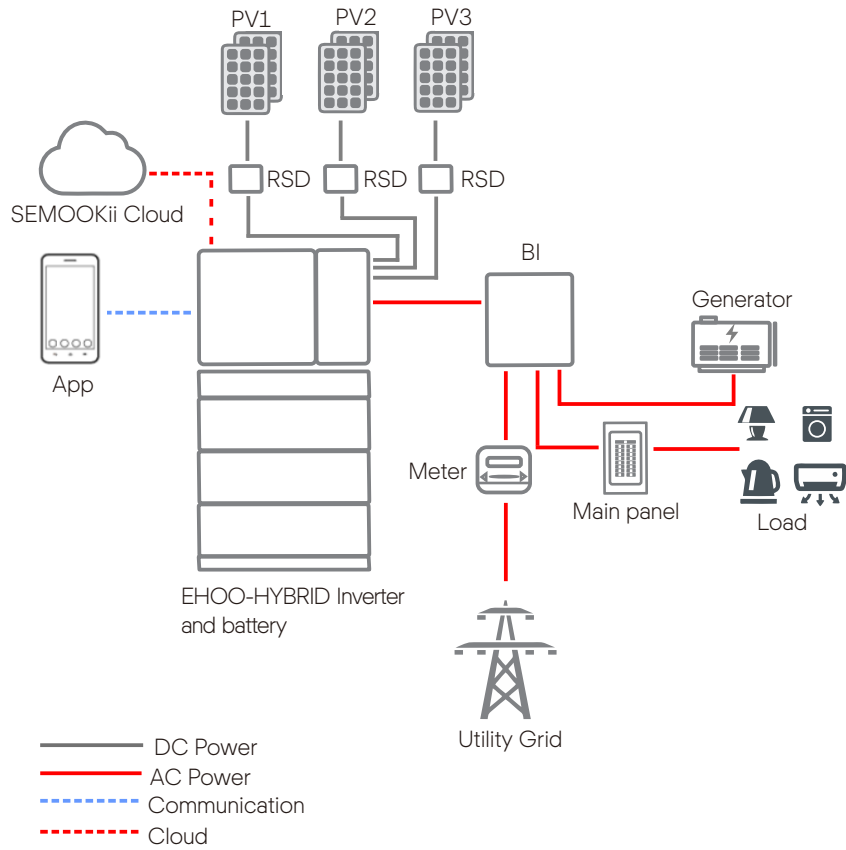

System overview of EHOO-AC COUPLED

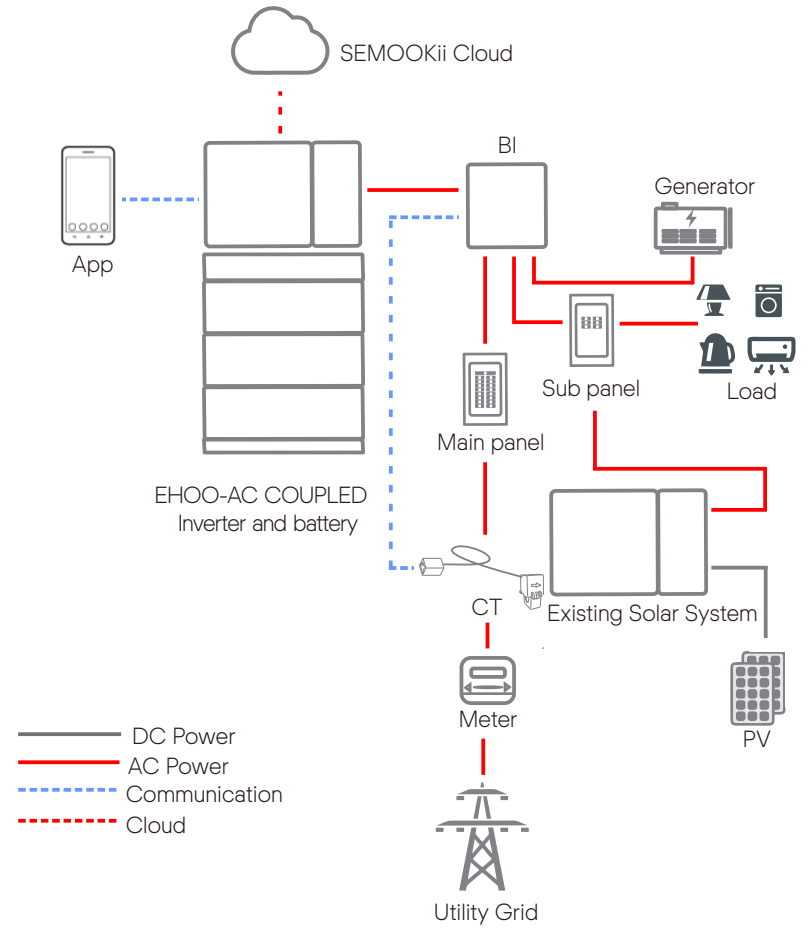

3.2 Work Modes

EHO0-HYBRID series inverter provides multiple work modes based on different requirements. Some basic work modes of EHO0-HYBRID are shown below. Contact us for additional or more complex application requirements.

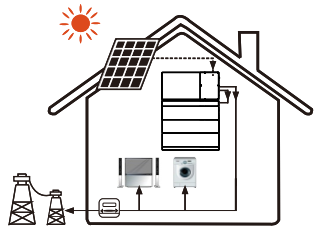

Work mode: **Self Use**

The self-use mode is suitable for areas with low feed-in tariffs and high electricity prices.

- ① When the power of PV is sufficient
The power generated from PV will be used to supply the local loads first, then proceed to charge the battery bank.
If the battery is fully charged, the excess power will be exported to the public grid. (The inverter will limit the output if Feed-in limit or zero feed-in is needed)
($PV > Load$, $PV \rightarrow Load \rightarrow Battery \rightarrow Grid$)

- ② When the power of PV is insufficient
The power from PV and battery will be used to supply the local loads. If the power is still not enough, the remaining power will be taken from the grid.
($PV < Load$, $PV + Battery + Grid \rightarrow Load$)

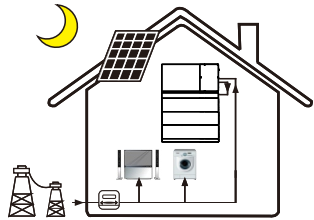

③ Without PV power

- The power from battery will be used to supply the local loads firstly. If the battery power is not enough, the remaining power will be taken from the grid. The inverter will enter into the standby state.
($PV = 0$, $Battery + Grid \rightarrow Load$)

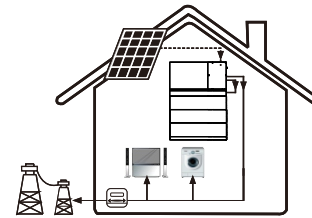

Work mode: **Feed-in priority**

The Feed-in priority mode is suitable for areas with high feed-in tariffs, but has feed-in power limitation.

- ① When the power of PV is sufficient
The power generated from PV will be used to supply the local loads firstly, and the excess power will feed-in to the grid.
($PV > Load$, $PV \rightarrow Load \rightarrow Grid$)

- ② When the power of PV is insufficient
The power from PV and battery will be used to supply the local loads.
If the power is still not enough, the remaining power will be taken from the grid.
($PV < Load$, $PV + Battery + Grid \rightarrow Load$)

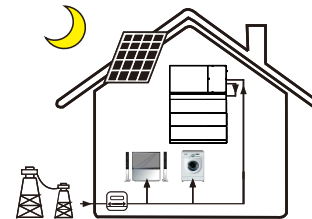

③ Without PV power

- The power from battery will be used to supply the local loads firstly. If the battery power is not enough, the remaining power will be taken from the grid. The inverter will enter into the standby state.
($PV = 0$, $Battery + Grid \rightarrow Load$)

Work mode: **Backup mode**

Priority: **battery > load > grid**

This mode applies to regions with frequent power outages. This work mode will ensure the battery to reserve a minimum capacity for grid outage.

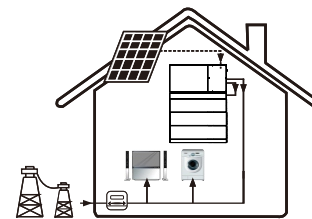

In this work mode, the battery will be charged at the set time and will never discharge when the grid is on. You can also choose whether to charge from the grid or not.

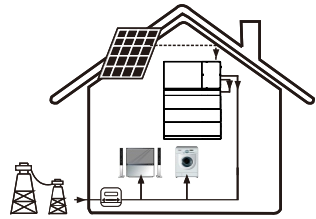

Work mode: **Time of Use mode**

The Time of Use mode applies to areas that have different electricity prices depending on the day, time and season.

Priority: load > battery > grid (when discharging)
Priority: battery > load > grid (when charging)

The power generated from PV will be used to supply the local loads first, then proceed to charge the battery bank. The excess power will be exported to the public grid.

Charges the battery during two available charging windows from PV or grid (if enabled), then functions as in Self-use mode

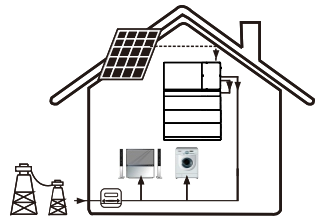

Work mode: **Demand Mode**

The demand mode is suitable for the areas with high Critical Peak Pricing or areas with limited capacity of distribution transformers.

In this mode, battery discharges during two discharge windows to limit demand charge (if enabled) (Similar to Time of Use mode but on Demand Mode the system will allow grid consumption up to a threshold limit defined by the user.)

3.3 Dimensions

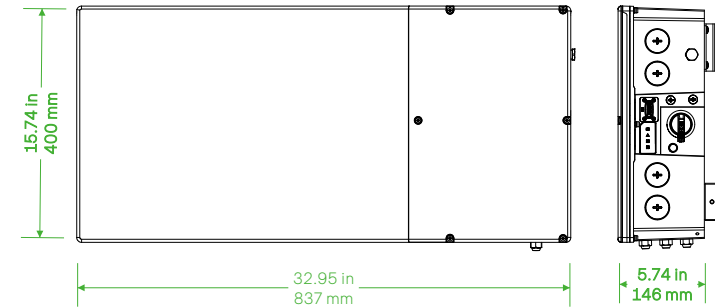

3.4 Overview of the Inverter

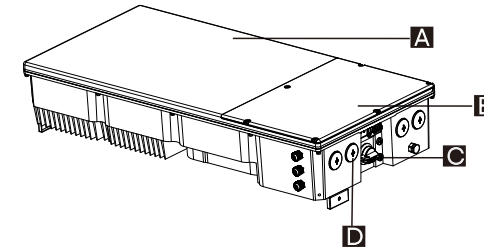

A-Inverter power box: It is the essential part of the inverter. This part is debugged and sealed before ex-factory and there is no user-servable part inside this part. Opening the part is prohibited.

B-Wiring box: It is the compartment where all the wiring are connected. Open the wiring box cover to complete all the wiring connection.

C-DC power: It is the power switch that allows for the DC power to be off or on for the inverter.

D-Conduit plugs: There are four 1 inch openings for wiring connection. Each conduit opening is fitted with a conduit plug which needs to be removed before installation and wiring connection.

3.5 External Terminals of an Inverter

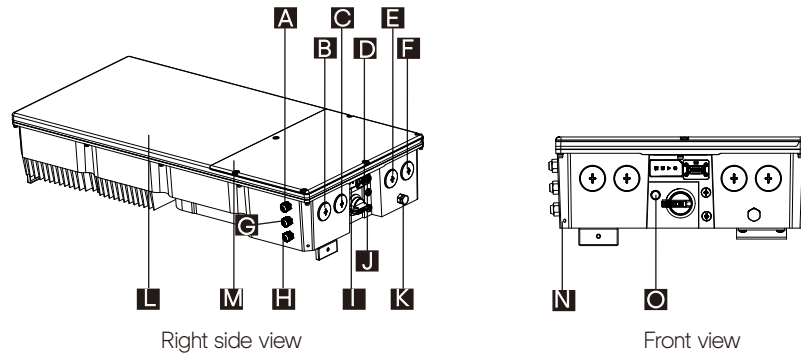

Item	Description
A	BAT+
B	AC connection
C	Inverter communication connection
D	DC switch
E	PV connection
F	PV connection
G	Battery communication connection
H	BAT-
I	Inverter indicator
J	Communication port or USB port for upgrading
K	Waterproof valve
L	Inverter power box
M	Wiring box
N	Ground terminal with battery
O	Power button



NOTE!

The inverter power box (section L) is sealed at the factory and there are no user-serviceable parts inside.

3.6 Internal Terminals in Wiring Box

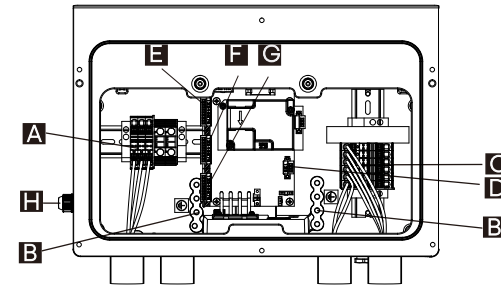

Item	Description
A	AC terminals
B	Grounding bar
C	PV terminals
D	MLPE terminal
E	COMM in terminal
F	COMM out terminal
G	AUX terminal
H	Battery terminals



NOTE!

Not all communication wirings connected with the terminals on the communication board are shown in the picture. Refer to the Section 6 for the details on communication connection.

3.7 Identification of EHOO-HYBRID Series

Model	Parameter	Serial Number Identification
<p>GRID SUPPORT UTILITY-INTERACTIVE TRANSFORMERLESS INVERTER SEMOOKII</p> <p>Model: EHOO-HYBRID-3.8</p> <p>PV INPUT</p> <p>Max.DC Voltage 550 Vd.c.</p> <p>Operating Voltage range 90-500 Vd.c.</p> <p>No. of MPPT/Strings per MPPT 2/1</p> <p>Max.DC Current per MPPT 16 A</p> <p>Max.DC Power 5700 W</p> <p>GRID OUTPUT/ INPUT</p> <p>Nominal AC Voltage 120/240 Vac split phase</p> <p>Max. Continuous Current 15.9 A</p> <p>Max. Continuous AC Power 3816 VA</p> <p>Nominal AC Frequency 60 Hz</p> <p>Operating Frequency Range 59.3 Hz-60.5 Hz</p> <p>AC Output Power Factor 0.8 Leading- 0.8 Lagging</p> <p>BATTERY</p> <p>Battery Type Li-ion</p> <p>Nominal DC Voltage 150 Vd.c.</p> <p>DC Operating Voltage Range 75-450Vd.c.</p> <p>Max. Charge / Discharge Current 54 A / 54 A</p>	<p>Nominal DC Voltage 150 Vd.c.</p> <p>DC Operating Voltage Range 75-450Vd.c.</p> <p>Max. Charge / Discharge Current 54 A / 54 A</p> <p>OTHER</p> <p>Enclosure Type Type 4X</p> <p>Operating Temperature -13°F~+140°F no derating below 113°F</p> <p>UL 1741 / UL 62109-1 / CSA1071</p> <p>Inverter SN: [Redacted]</p> <p>SEMOOKII BESS CO., LTD. ADD: No. 2399 Fazhan Ave., Haimen Port New Area, Jiangsu 226156, China TEL: +86 21-60970158 E-mail: sales@semookii.com</p> <p>MADE IN CHINA 3202104700</p>	<p>Serial Number Identification</p> <p>MH2 076 E 7 0 0 1 0 0 1</p> <p>Model Power Year Month Work Order Number Serial Number</p>

1. Every EHOO-ESS series product corresponds to a unique serial number. The serial number is divided into five parts: type (3 bits)+ power (3 bits)+ year/month (2 bits)+ work order number (3 bits)+ stream number (3 bits), a total of 14bits.

2. The standard series number rules is as follows:

MH2	076	E	7	0	0	1	0	0	1
Model	Power	Year	Month	Work Order Number			Serial Number		

MH2:EHOO-HYBRID; MA2:EHOO-AC COUPLED; MS2:EHOO-SOLAR
 076: Power ----7.6 KW;
 E: Year ----- I:2022 (A:2014; B: 2015.....)
 7: Month ----- July (October :A, November ;B, December.....)
 001: Work order number ---- 001:001~999 (Monthly zero clearing)
 001: Serial number----- 001:001~ZZZ (will be cleared for next work order).

4 Technical Data

4.1 PV Input

Model	EHOO-HYBRID-3.8	EHOO-HYBRID-5.0	EHOO-HYBRID-6.0	EHOO-HYBRID-7.6
Max.recommended PV power [W]	7600	10000	10000	15200
Max.MPPT power [W]	5700	7500	9000	11400
Max.DC voltage [V]	550			
Normalinal DC operating voltage [V]	360			
Max. input current [A]	A:16/B:16		A:16/B:16/C:16	
Max. short circuit current [A]	A:20/B:20		A:20/B:20/C:20	
MPPT voltage range [V]	90-500			
MPPT voltage range [V](full load)	176-500	232-500	278-500	235-500
Start input voltage [V]	120			
No. of MPP trackers	2		3	
Strings per MPP tracker	A:1/B:1		A:1/B:1/C:1	
DC disconnection switch	Yes			
AFCI	Yes			
Max. inverter backfeed current to the array [A]	27 A rms / 1 cycle, 400 A peak / 0.02 ms			

4.2 AC Input/Output

Model	EHOO-HYBRID-3.8	EHOO-HYBRID-5.0	EHOO-HYBRID-6.0	EHOO-HYBRID-7.6
Normalinal AC power [VA]	3816	5016	6000	7608
Max. apparent AC power [VA]	3816	5016	6000	7608
Rated grid voltage [V]	240			
Rated grid Frequency [Hz]	60			
Normalinal AC current [A]	15.9	20.9	25	31.7
Max. Output Continuous current [A]	15.9	20.9	25	31.7
Maximum output fault current and duration [A/ ms]	48/90			
Maximum output fault peak current and duration [A/ ms]	515/5			
Displacement power factor	0.8 leading to 0.8 lagging			
Total harmonic distortion (THD, rated power)	<3%			
Parallel operation	Yes			
Maximum output overcurrent protection [A/ P]	20/2	25/2	30/2	40/2

4.3 General Data

General	EHOO-HYBRID-3.8	EHOO-HYBRID-5.0	EHOO-HYBRID-6.0	EHOO-HYBRID-7.6
Dimensions with Safety Switch (WxHxD) [in(mm)]	33.1*15.7*5.7 (840*400*146)			
Weight with Safety Switch [lb(KG)]	75 (34)			
Cooling concept	Natural convection with internal fan			

Model	EHO0-HYBRID-3.8	EHO0-HYBRID-5.0	EHO0-HYBRID-6.0	EHO0-HYBRID-7.6
Topology	Transformerless			
Communication	Rs485, CAN, WiFi (optional) / 4G (optional)			
Revenue Grade Data, ANSIC12.20	Optional			
Warranty [Years]	10			

4.4 Battery Input/Output

Model	EHO0-HYBRID-3.8	EHO0-HYBRID-5.0	EHO0-HYBRID-6.0	EHO0-HYBRID-7.6
Battery type	Li-ion			
Input/output voltage range [V]	75-450			
Rated input/output voltage [V]	150			
Maximum input power [W]	4060	5336	6383	8094
Maximum output power [W]	3816	5016	6000	7600
Maximum Input/output current [A]	54			
Reverse-Polarity Protection	Yes			
Cycle efficiency charging to discharging (PCS Only)	88.5%	90.5%	91.5%	92.5%

4.5 Efficiency, Power Consumption and Standard

Model	EHO0-HYBRID-3.8	EHO0-HYBRID-5.0	EHO0-HYBRID-6.0	EHO0-HYBRID-7.6
CEC Weighted Efficiency (PV to GRID)	97.0%	97.5%	97.5%	97.5%
Maximum Inverter Efficiency	98.0%	98.0%	98.0%	98.0%
Power consumption				
Internal consumption(night) [W]	<3W			
Standard				
Safety	UL1741,UL1741 SA,UL1699B, CSA C22.2 No. 107.1-16, CSA C22.2 No.292-18			
EMC	FCC part15 class B			
Certification	IEEE1547, Rule 21,Rule14 (HI)			
RoHS	Yes			

4.6 Environment Limit

Environment limit	EHO0-HYBRID-3.8	EHO0-HYBRID-5.0	EHO0-HYBRID-6.0	EHO0-HYBRID-7.6
Protection class	NEMA 4X			
Operating Temperature Range [°F (°C)]	-13 to +140 (-25 to +60)			
De-rating start temperature [°F (°C)]	113 (45) or above			
Storage temperature Range [°F (°C)]	-13 to +167(-25 to +75)			
Humidity [%]	0%~95% RH			
Altitude [ft (m)]	9843 (3000) MAX			
Noise emission(typical) [dBA]	< 30			
Overvoltage category	IV (electric supply side), II (PV side)			

5. Mechanical Installation

5.1 Installation Precaution



WARNING!

Read all of these instructions, cautions, and warnings for the EHO0-HYBRID series inverter.



WARNING!

Installation and commissioning must be performed by a licensed electrician in accordance with local, state and National Electrical Code ANSI/NFPA 70 requirements.



WARNING!

The installation and wiring connection methods of this inverter in the U.S. must comply with all US National Electric Code and local requirements.



CAUTION!

Personal injury and machine damage may be caused by improper movement of the inverter. Please be strictly comply with the instructions of this manual when moving the install the inverter.

5.2 Selection for the Installation Position

The installation location selected for the inverter is quite critical in the aspect of the guarantee of machine safety, service life and performance.

- EHO0-HYBRID series has the NEMA 4X ingress protection, which allows it to be installed outside the door.
- The installation position shall be convenient for wiring connection, operation and maintenance.

5.2.1 Installation Environment Required

The installation position shall be well ventilated.

Make sure the installation site meets the following conditions:

- Not be exposed to glare.
- Not in areas where highly flammable materials are stored.
- Not in potential explosive areas.
- Not near the television antenna or antenna cable.
- Not higher than altitude of about 9843 ft (3000 m) above sea level.
- Not in environment of precipitation.
- Be sure the ventilation is good enough.
- The ambient temperature in the range of -13°F (-25°C) to $+140^{\circ}\text{F}$ ($+60^{\circ}\text{C}$).
- The slope of the wall should be within $\pm 5^{\circ}$.
- Avoid direct sunlight, rain exposure, snow laying up during installing and operating.

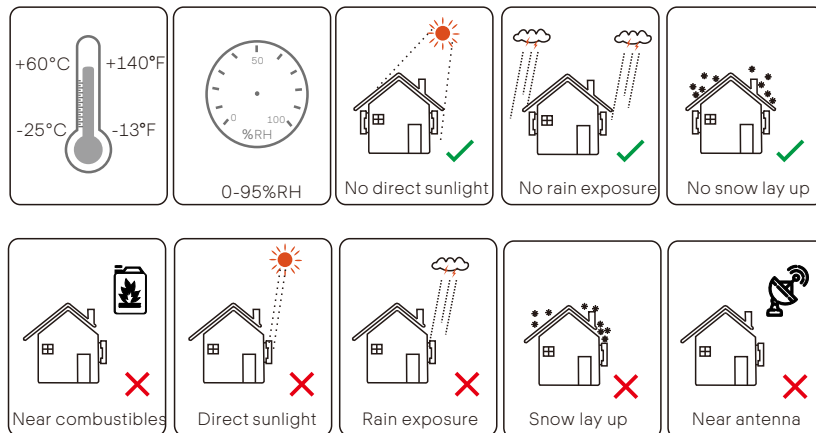

5.2.2 Installation Carrier Required

The wall or stand hanging the inverter should meet conditions below:

- Wooden wall with studs spaced at 12, 16, 20, 24, 28 and 32 inch.
- Solid brick / concrete, or strength equivalent mounting surface.
- Steel material of sufficient thickness.

Inverter must be supported or strengthened if the strength of wall/stand isn't enough. (such as the wall covered by thick layer of decoration)

5.2.3 Installation Angle Required

Install the inverter at a maximum back tilt of 5 degrees and avoid forward tilted, excessive backward tilted, side tilted or upside down.

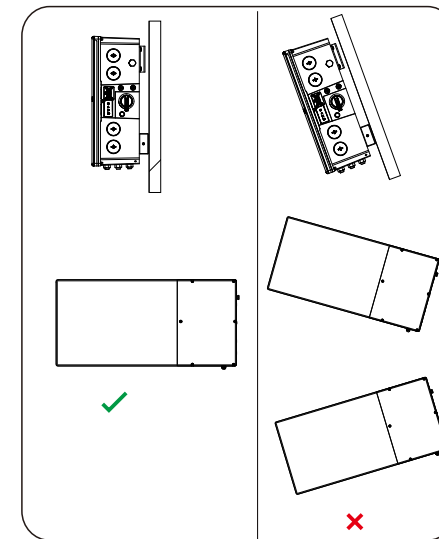

5.2.4 Installation Space Required



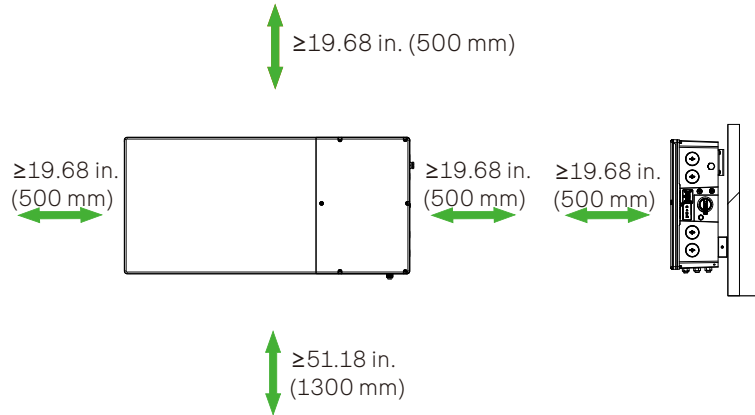



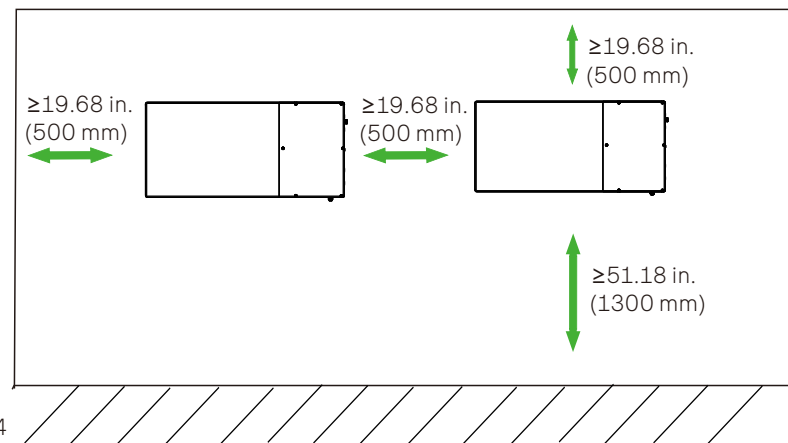



To ensure good heat dissipation and convenient disassembly, the minimum clearance around the inverter shall not be less than the following values, as shown in the following figure. The height above the ground marked below is recommended assuming that three BATs are mounted. If less or more BAT is mounted, please lower or increase the height accordingly. (the height of one BAT is about 300 mm)

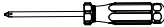
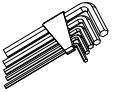
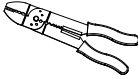
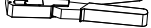

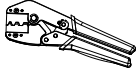
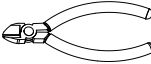

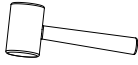

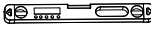
For multi-inverter installation, please reserve the space of 19.68 in. (500 mm) at least between each left and right inverter and at least 19.68 in. (500 mm) space from the ceiling and 51.18 in. (1300 mm) above the ground. If multiple inverters are mounted in areas with high ambient temperatures, increase the clearances between the inverters and ensure an adequate fresh-air supply if possible.

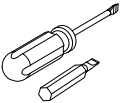

5.3 Tools Preparation

Tool equipment				
Type	Name	Image	Name	Image
Machine Installation Tools	Drill		Multimeter	
	Crosshead screwdriver		Allen key	
	Wire stripper Crimping tool		Crimping tool for RJ45	
	Utility knife		MC4 crimping tool	
	Diagonal pliers		Marker	
	Mallet		Measuring tape	
	Spirit level		Hot-air blower	
	Electrical hex wrench		Flat-head screwdriver	

Tool equipment				
Type	Name	Image	Name	Image
Individual Protection Tool	Safety gloves		Safety shoes	
	Safety goggles		Anti-dust mask	

5.4 Check for Transport Damages

EHOH-HYBRID series inverter is 100% tested and packaged and visually inspected before leaving our manufacturing facility. Please make sure the inverter is intact during transportation. If there are some visible damages, such as cracks, please contact your dealer immediately.

5.5 Packing Lists

Open the package, fetch out the product and check the accessories. The packing list shows as below.

In the inverter box



A

In the inverter accessory box

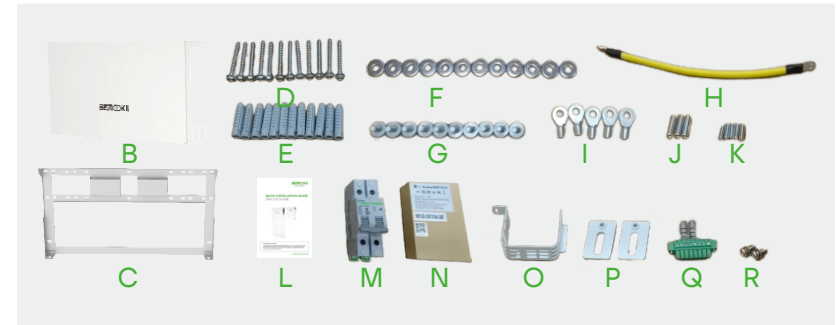

Item	Name	Description
A	Inverter X1	Product
B	Mental cover X1	Protect the inverter
C	Bracket X1	Support the inverter
D	Self-tapping screwX12	Fix the bracket
E	Expansion boltX12	Fix the bracket
F	WasherX12	Fix the bracket
G	M5X10 screwX10	Fix the cover, cable protective guard and cover fixing plate
H	Grounding terminalX5	For grounding
I	PE cableX1	Grounding cable between inverter and BMS
J	8 AWG ferrules X3	For AC cable
K	10 AWG ferrules X6	For PV cable
L	DocumentsX3	Guide the installation and maintenance of the inverter
M	Circuit breakerX1	Mount it on the BI
N	Communication dongleX1 (Optional)	For communication
O	Cable protective guardX1	Protect the cable between inverter and BMS
P	Fixing plate of coverX2	Connect the cover and the bracket
Q	8-pin female terminal block with terminating resistorX1	Additional 8-pin female terminal block with terminating resistor
R	M4X10 screwX2	Fix the fixing plate between inverter bracket and BMS

5.6 Installation Steps

5.6.1 Overview of Bracket and Schemes

➤ Introduction of wall bracket

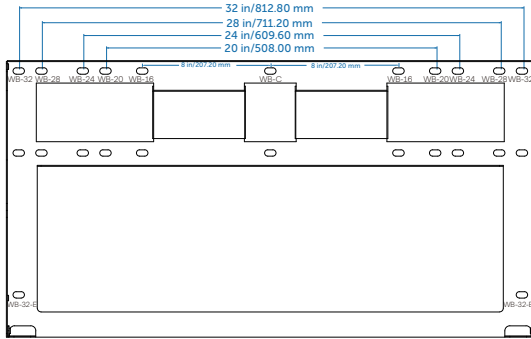

➤ Introduction of schemes

The scheme of hole punch differs from different wall with different characteristics.

Scheme A:

Studs at regular intervals (spaced at 12 and 24inch):
Punch the holes (WB-24)X4+(WB-C)X2+(WB-32-E)X2

Steel material of sufficient thickness:
Punch the holes (WB-24)X4+(WB-C)X2+(WB-32-E)X2

Solid concrete or masonry:
Punch the holes (WB-24)X4+(WB-C)X2+(WB-32-E)X2

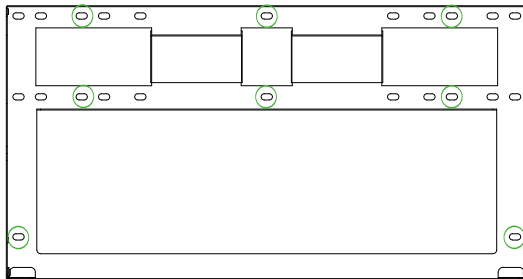

Scheme B:

Studs at regular intervals (spaced at 16 and 32 inch):
Punch the holes (WB-32)X4+(WB-C)X2+(WB-32-E)X2

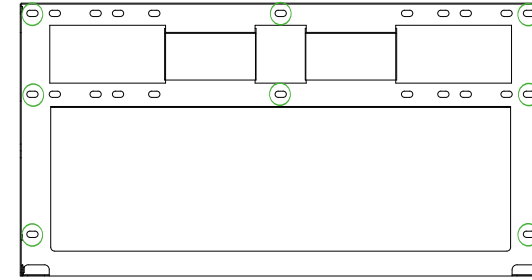

Scheme C:

Studs at regular intervals (spaced at 20 inch):
Punch the corresponding holes (WB-20)X4+(WB-C)X2+(WB-32-E)X2

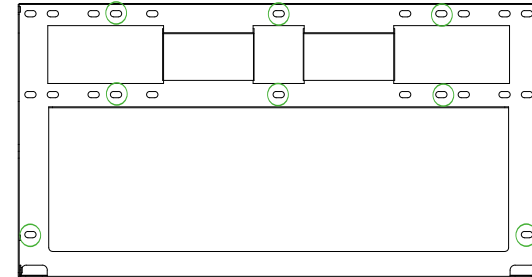

Scheme D:

Studs at regular intervals (spaced at 28 inch):
Punch the corresponding holes (WB-28)X4+(WB-C)X2+(WB-32-E)X2

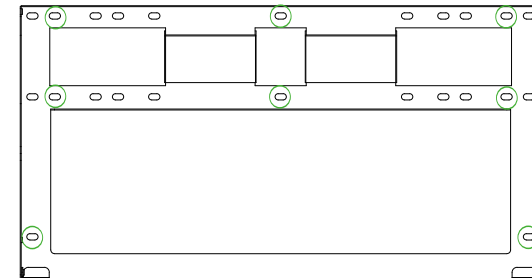

5.6.2 Mounting Steps



NOTE!

The mounting steps in the followings will take mounting on the wooden wall spaced at 32 inch as an example.



NOTE!

Before mounting the inverter, the mechanical installation of the whole battery must be completed.

Step 1: Fix the bracket

a) Two M4 holes are reserved on the BMS for fixing the bracket of the inverter.

- Screw in M4 screws to pre-fix the bracket on the BMS but be sure not to tighten.
- Hold the bracket firmly to the wall surface.
- Tighten the M4 screws to fix the bracket on the BMS.

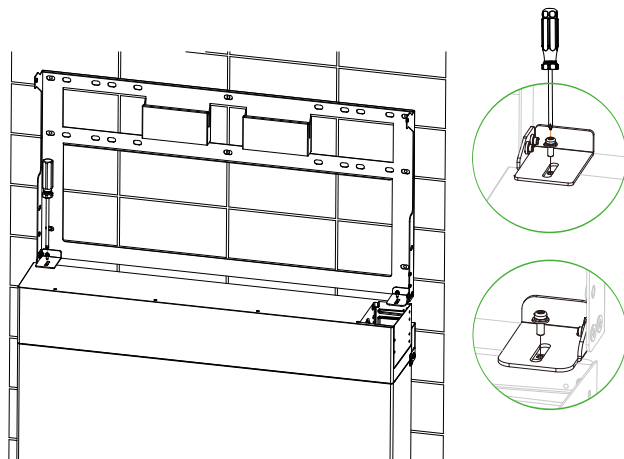

⊕ M4
 ↻ 4.4 lbf.in / 0.5 N·m

b) Use the bracket as the template to mark the screw hole location on the wall.

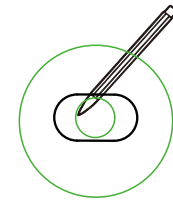
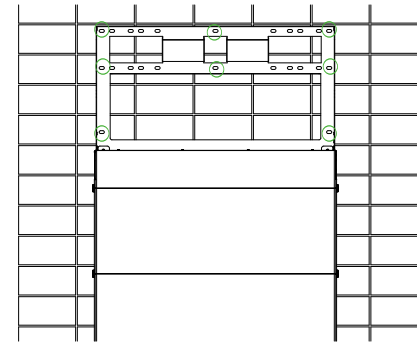

Round holes

c) Unscrew the two M4 screws to disassemble the bracket. Drill holes with power drill, and make sure the holes are deep enough (2.1 in. / 55.0 mm) to support the inverter.



NOTE!

The figure below is only used for showing the depth and location of holes. Make sure the holes are in the center of each stud and keep at least 1.5 in. / 38 mm away from the edge of concrete bricks or studs before marking holes.

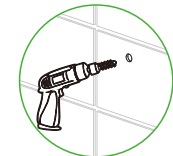
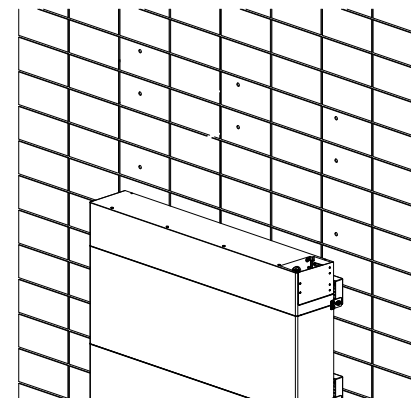

Φ10 drill
 Depth:
 2.1 in. / 55.0 mm



NOTE!

For wooden wall, please use Φ10 drill.

d) Insert the expansion tube into the hole and use rubber hammer to knock the expansion tube into the wall. (This step is not required in case of wooden wall.)

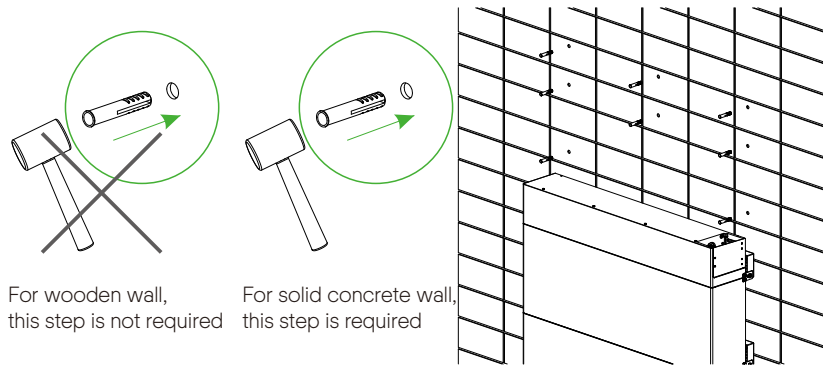

For wooden wall, this step is not required

For solid concrete wall, this step is required

e) Align the bracket over the holes and re-fix the bracket on the BMS with screws. Set the tapping screw through the washer and secure the bracket with tapping screws. Please hold the bracket firmly to the wall surface before fixing it.

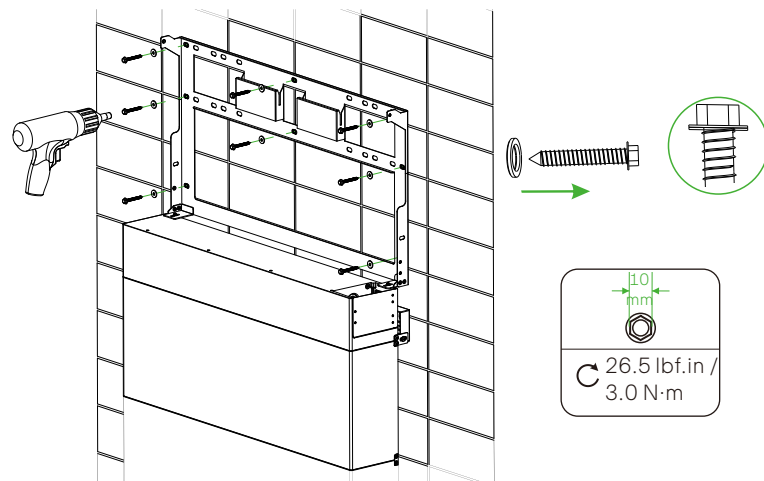

⌚ 26.5 lbf.in / 3.0 N.m

Step 2: Hang and fix the inverter on the bracket

a) Place the inverter to be seated on the corresponding position of the bracket. As EHOO-HYBRID series inverters are heavy, weigh 75 lbs / 34 Kg, it should be lifted up by two persons and placed carefully onto the bracket. Then adjust the inverter to be centered on the whole system;

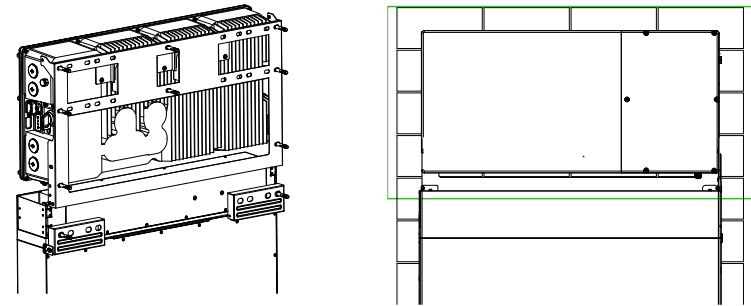

Back view

Front view

b) Place the cable protective guard on the correct position of battery's BMS prior to the wiring connection between inverter and battery and secure it on the inverter's bracket with M5 screws;

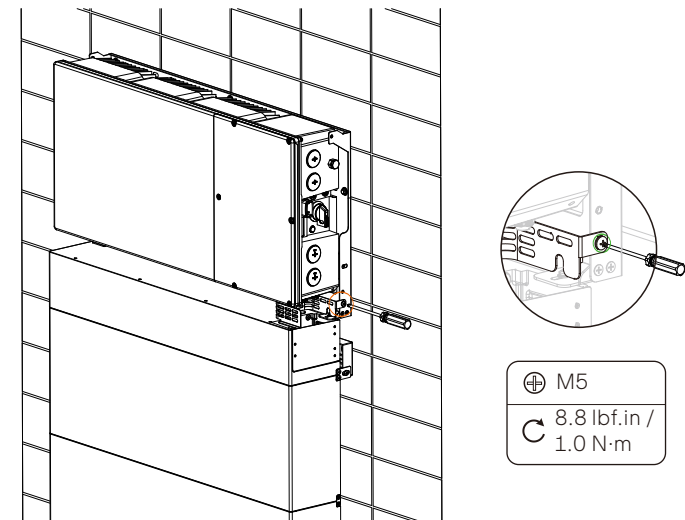

⊕ M5
⌚ 8.8 lbf.in / 1.0 N.m

c) Pre-mount the fixing plate on the two sides of metal cover and mount the metal cover on the inverter. Please make sure the four dowel pins are inserted into the holes of BMS and adjust the whole system (inverter and battery) to be leveled;

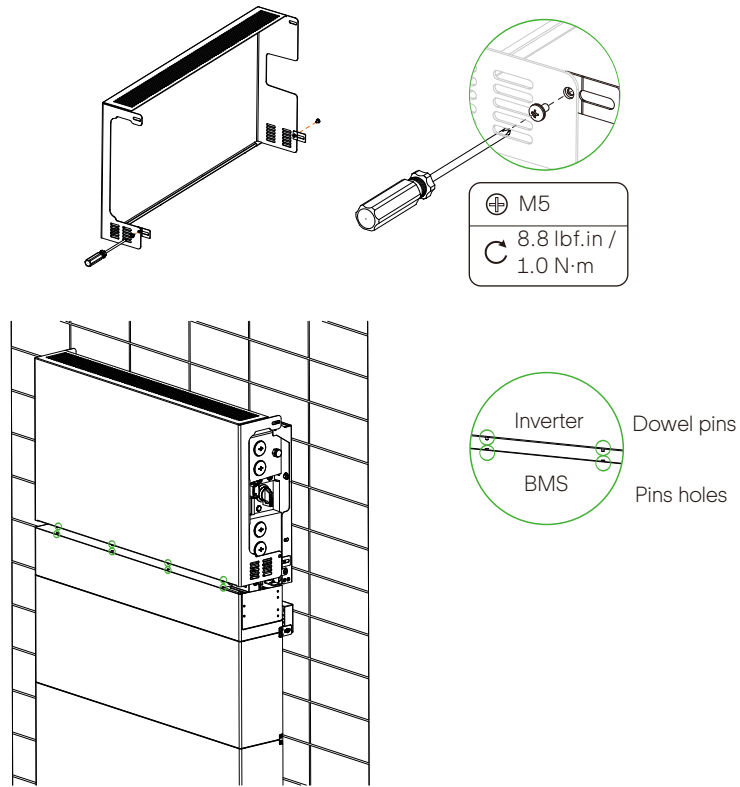

NOTE!

Before mounting the metal cover, the wiring connection between battery and inverter must be completed. For detailed information about how to connect the battery to the inverter, please refer to Chapter 6 "Electrical Connection".

d) Fix the metal cover with six M5 screws.

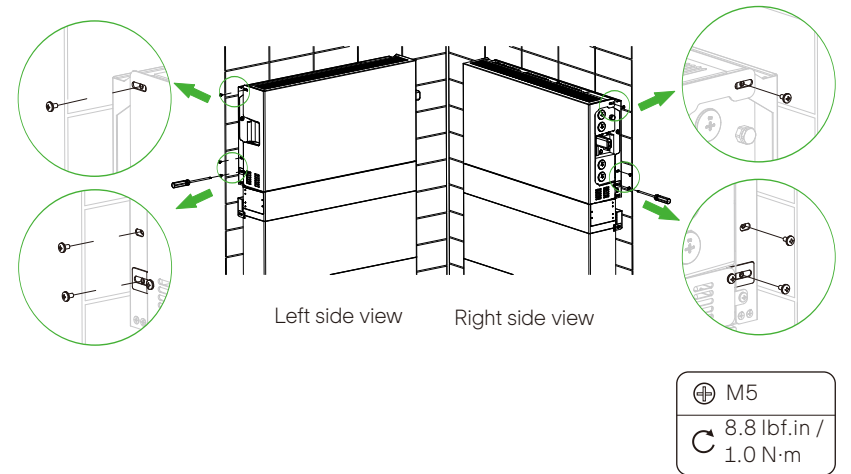

6 Electrical Connection



WARNING!

Read all of these instructions, cautions, and warnings for the EHOO-HYBRID series inverter.



WARNING!

All electrical installations must be carried out in accordance with all applicable Local and National Codes. Before connecting the inverter to the grid, approval must be received by local utility as required by national and state interconnection regulations.



DANGER!

Danger to life due to high voltages of the PV array

When exposed to sunlight, the PV array generates dangerous DC voltage which is present in the DC conductors and the live components which can lead to lethal electric shocks. If you unplug the terminal plate with the connected DC conductors from the DC-in slot under load, an electric arc may occur, which will cause an electric shock and burns.

- Do not touch non-insulated conductors.
- Do not touch the DC conductors.
- Do not touch any live components of the inverter.



WARNING!

Damage to seals on the enclosure lids in subfreezing condition. If you open the enclosure lids of the wiring box when temperatures are below freezing, the enclosure lid seal could be damaged. As a result, moisture can get into the wiring box. Only open the enclosure lid of the wiring box if the ambient temperature is at least 32°F (0°C) and there is no frost.



WARNING!

Damage to the inverter due to electrostatic discharge. Touching electronic components will cause damage to or destroy the inverter through electrostatic discharge. Ground yourself before touching any component.



WARNING!

Damage to the inverter due to moisture ingress during installation! Never open the inverter when it is raining or snowing, or the humidity is over 95%. For attaching conduit to the enclosure, only use UL-listed rain-tight conduit fittings or UL-listed conduit fittings for wet locations complying with UL514B. Seal all unused openings tightly.

6.1 Overview of All Electrical Wiring Methods

All electrical wiring will be done in the wiring box, and all electrical wiring methods are similar. Therefore this section will introduce all electrical wiring steps and requirements.

• Required wire size and torques

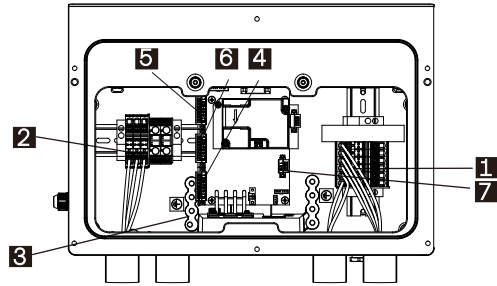

Inverter power terminal (Purchased by customer)

No.	Terminals	Type	Cross-sectional Area Range	Strip Length
1	PV terminals	90°C(194°F), 600V, copper	10-8 AWG	0.47 in/12 mm
2	AC terminals	90°C(194°F), 600V, copper	12-8 AWG (3.8KW), 10-8 AWG (5/6/7.6KW)	0.47 in/12 mm
3	Ground terminals	90°C(194°F), 600V, copper	8 AWG	0.47 in/12 mm

Inverter communication terminal (Purchased by customer)

No.	Terminals	Port Pin	Type	Cross-sectional Area Range
4	AUX terminal	Pin 1: RS485_METER_A	CAT5 or better	24-18 AWG
		Pin 2: RS485_METER_B		
		Pin 3: GND		
		Pin 4: +12V_RELAY_OUT		
		Pin 5: DRMO		
		Pin 6: +12V_COM		
		Pin 7: STOP_NO+		
		Pin 8: STOP_NO-		
5	COMM in terminal	Pin 1: SYSR_L	CAT5 or better	24-18 AWG
		Pin 2: SYSR_H		
		Pin 3: CAN_L		
		Pin 4: CAN_H		
		Pin 5: RS485_BI_A		18-16 AWG
		Pin 6: RS485_BI_B		
		Pin 7: +12V		
		Pin 8: GND		
6	COMM out terminal	Pin 1: SYSR_L	CAT5 or better	24-18 AWG
		Pin 2: SYSR_H		
		Pin 3: CAN_L		
		Pin 4: CAN_H		
		Pin 5: RS485_BI_A		18-16 AWG
		Pin 6: RS485_BI_B		
		Pin 7: +12V		
		Pin 8: GND		
7	MLPE terminal	Pin 1: GND	CAT5 or better	24-18 AWG
		Pin 2: RS485_MLPE_A		
		Pin 3: RS485_MLPE_B		



NOTE!

The strip length of the terminals is 0.24 in / 6 mm. The torque is 1.8 in-lbs / 0.2 N·m.

• Opening the wiring box cover



WARNING!
 Before inverter wiring connection, Make sure no live voltages are present on PV input and AC output circuits, and make sure that the DC switch is in “OFF” position, meanwhile, the breaker of battery is in OFF position.

Step 1: Turn DC switch to “OFF” position. Note that the cover cannot be removed when the DC switch is in “ON” position.

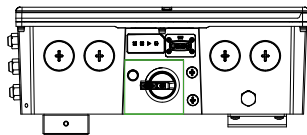

Step 2: Make sure the breaker of battery is in OFF position.

Step 3: Remove the 6 cover screws using Allen key, then disassemble the cover.

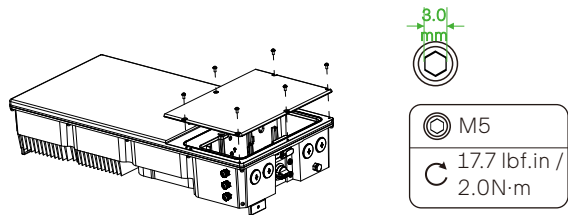

• Removing wiring box waterproof plugs

EHO0-HYBRID series inverter is equipped with four 1 inch conduit fittings which are used for electrical wiring access. Four waterproof plugs have been installed on the inverter at the factory. Before wiring connection, these waterproof plugs should be removed by the operator.

Step 1: Remove the waterproof plugs by placing a flat blade screwdriver in the slot on the waterproof plug face and turning while gripping the nut on the inside of the enclosure to ensure it does not slip.

Step 2: Unscrew the nut from the waterproof plug and slip the conduit plug out of the waterproof opening.

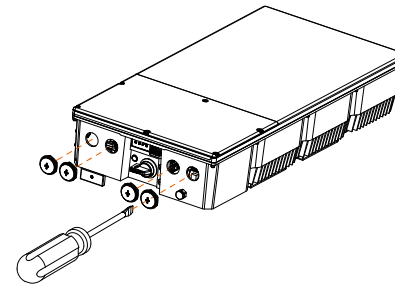

• Conduit installation

Operator should use the conduits and plugs with standard size which must fit with the holes on the right side of the inverter. Conduit fittings need to be water tight, and an insulated type is preferred.

Once conduit and fittings are installed, wires should go through the conduit and be locked into the corresponding terminals.

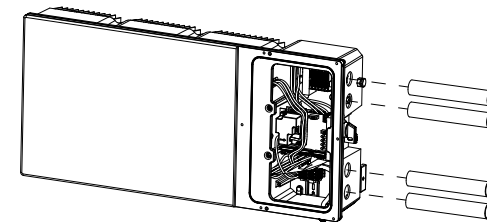

• **Cable entry of inverter**

A conduit fitting or cable gland must be used when wiring connection. The cable is routed from the right side of inverter.

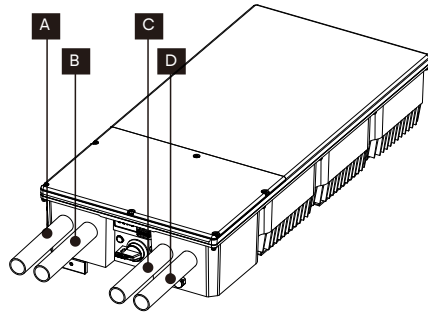

Item	Type of Cable Entry
A	Conduit plug for AC connection
B	Conduit plug for communication connection
C	Conduit plugs for PV connection
D	Conduit plugs for PV connection

6.2 Power Connection

• **General steps of connecting electrical wirings to terminals**

- Step 1: Choose the appropriate wire according to the specific connection.
- Step 2: Remove 0.47 in / 12 mm of insulation from the end of DC wire and the AC wire.
- Step 3: Insert the end of wires into the Cord End Terminal, and then use the crimping tool to crimp the Cord End Terminal tightly (the shape will be square).
- Step 4: Use the slot screwdriver to compress the orange button of the terminals. Then insert stripped wires into the terminal and ensure that all conductor strands are captured in the terminal.
- Step 5: Loosen the slot screwdriver.

For the specific requirement of power cable, please refer to section 6.1 “Overview of All Electrical Wiring Methods”.

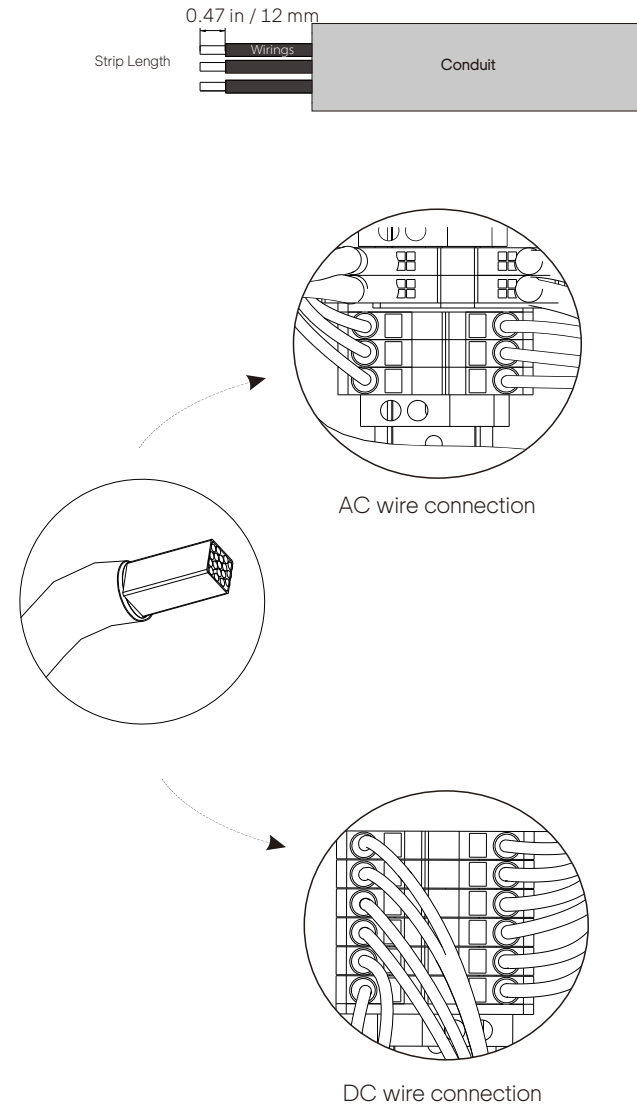

6.2.1 PV Connection



CAUTION!

Never reverse the polarity of the array string cables as it can cause damage to the inverter. Always ensure correct polarity.



WARNING!

Select PV modules with excellent functioning and reliable quality. Open-circuit voltage of module arrays connected in series should be less than the inverter Max. DC input voltage of 550 V. The inverter warranty is VOID if the DC input voltage is exceeded.



WARNING!

Ensure no live voltages are present on the PV input and AC output circuit, and verify that the DC disconnect, AC disconnect, and dedicated AC circuit breaker are in the "OFF" position before installation.



WARNING!

Use dark, opaque sheets to cover the PV solar panels before performing any wiring or connection.



WARNING!

Power is fed from more than one source and more than one live circuit. Note that all DC and AC terminals may carry current even without connected wires.



WARNING!

Ensure maximum protection against hazardous contact voltages while assembling PV panel installations. Both the positive and negative leads must be strictly isolated electrically from the protective ground potential (PE).

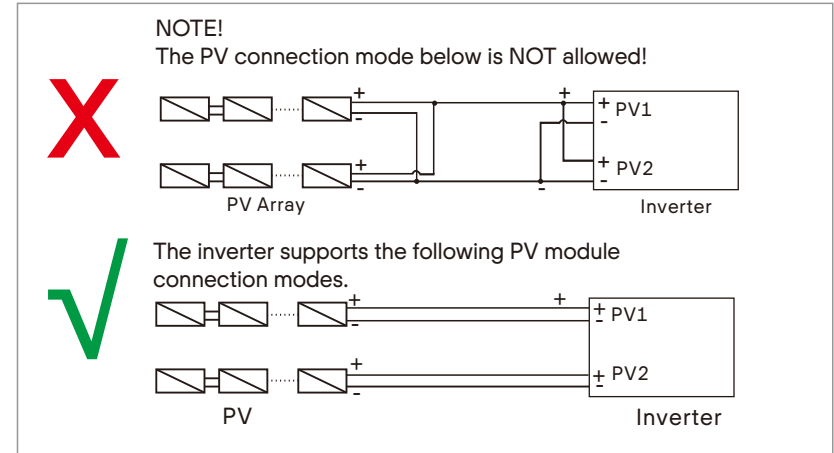

• PV String Connection

EHO0-HYBRID Series inverter can be connected with PV modules in series with 2 MPPTs for EHO0-HYBRID-3.8, EHO0-HYBRID-5.0 and EHO0-HYBRID-6.0, 3 MPPTs for EHO0-HYBRID-7.6.

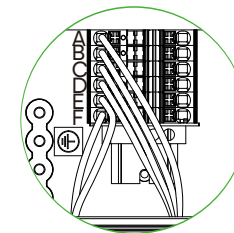
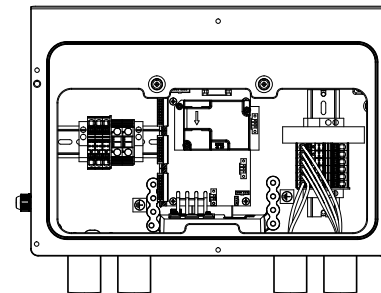

A: PV1 Positive terminal
C: PV2 Positive terminal
E: PV3 Positive terminal

B: PV1 Negative terminal
D: PV2 Negative terminal
F: PV3 Negative terminal

6.2.2 Grid Connection



CAUTION!

The installer is responsible for providing overcurrent protection. To reduce the risk of fire, only connect to a circuit provided with overcurrent protection in accordance with the National Electrical Code, ANSI/NFPA 70.

The connection procedure will vary depending on the grid configuration.

The following diagram provides an overview of the compatible grid configurations of which voltage limit, frequency limit and conductors have to be connected to the inverter to comply with the grid configuration.

- Public grid configuration allowed:

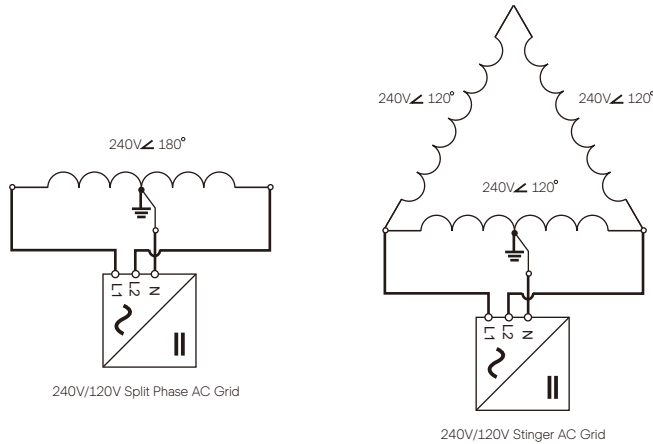

- Grid terminal connection on the side of inverter



CAUTION!
DANGER — HIGH VOLTAGE!

For the specific requirement of power cable, please refer to section 6.1 “Overview of All Electrical Wiring Methods”.

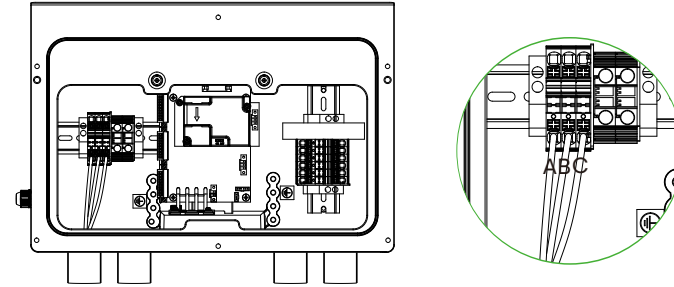

A: L1 terminal B: L2 terminal C: N terminal

- AC circuit breaker requirements

The AC circuit breaker (not included in the EHOO-HYBRID series inverter) is required to protect each AC line (L1 and L2) of the inverter. The circuit breaker should be able to handle the rated maximum output voltage and current of the inverter.

Refer to the table below to determine the specific circuit breaker in order to avoid potential fire hazards. The AC circuit breaker selection and installation must follow the National Electrical Code(NEC), ANSI/NFPA 70 or local electrical codes.

Inverter model	Description	Source
EHOO-HYBRID-3.8	2-pole, 20 A, 240 Vac	Purchase by customer
EHOO-HYBRID-5.0	2-pole, 30 A, 240 Vac	Purchase by customer
EHOO-HYBRID-6.0	2-pole, 35 A, 240 Vac	Purchase by customer
EHOO-HYBRID-7.6	2-pole, 40 A, 240 Vac	Purchase by customer

6.2.3 Battery Connection



CAUTION!

Never reverse the polarity of the battery cables as this will result in inverter damage. Always ensure correct polarity.

Charging and Discharging system of EHOO-HYBRID series inverter is designed for high-voltage lithium-ion battery.

As a Lithium-ion battery will be connected with HYBRID series inverter, the battery communication should be compatible with EHOO-HYBRID series inverter and the BMS must be connected between inverter and battery.

• Battery connection diagram for Lithium-ion battery

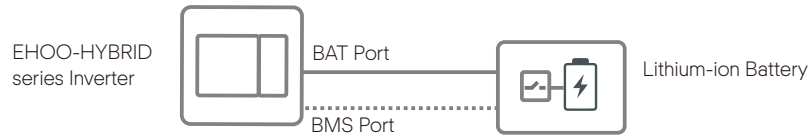

• BAT terminal connection



CAUTION!

DANGER — HIGH VOLTAGE!

Make sure the breaker of battery is in OFF position.

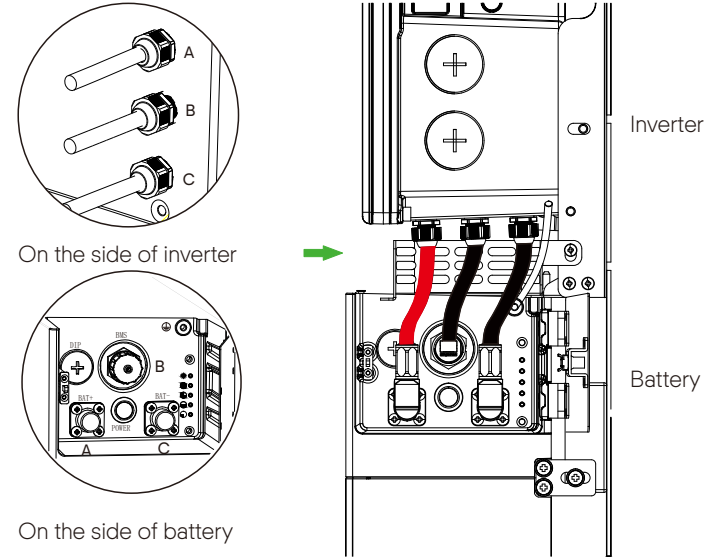

A: BAT+ B: Communication connection C: BAT-

1 The BAT+ (red), communication cable and BAT- (black) cables have been already connected on the inverter's side. Only connecting the other end of the cables to the corresponding port of BMS is needed.

2 Make sure that both ends of the cables are connected correctly to the connector on the right side of the BMS module.

6.3 Ground Connection

Please additionally earth the inverter to the enclosure of a second earthing or equipotential bonding if it is required by local safety. This prevents electric shock if the original protective conductor fails.

- **Ground Terminal**

Ground terminals are as follows. Terminals on bus-bar A and B are for AC and DC ground connection. Ground terminal C is for ground connection between inverter and battery

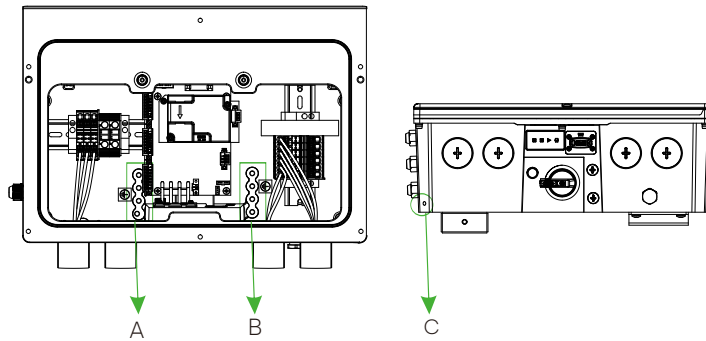

- **Steps of Ground Connection**

- a) Strip the insulation of conductor by wire stripper;
 - b) Pull the heat-shrink tubing over the PE cable and insert the stripped section into the grounding terminal;
- For the specific requirement of power cable, please refer to section 6.1 “Overview of All Electrical Wiring Methods”.

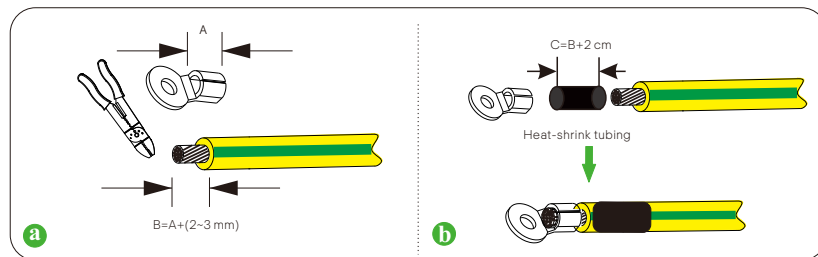

- c) Crimp it with crimping tool, pull the heat-shrink tubing over the stripped section of the grounding terminal and use a hot-air blower to shrink it so that it can be firmly contacted with the terminal;

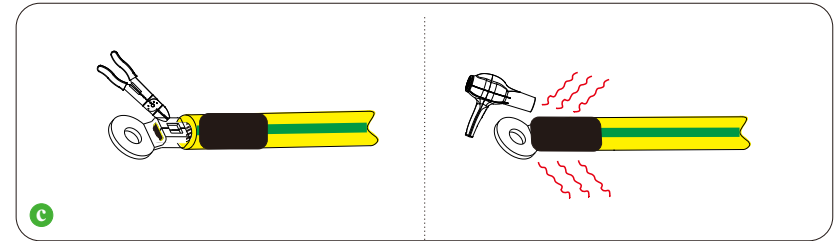

- d) Connect the ground cable to the inverter and fix it with M4 screw. When PV connection, please connect the ground cable to B bus-bars. When grid connection, please connect the ground cable to A bus-bars.
- e) Connect the ground cable between the inverter and battery with M5 screws. For easier connection, please connect the grounding cable on the BMS first.

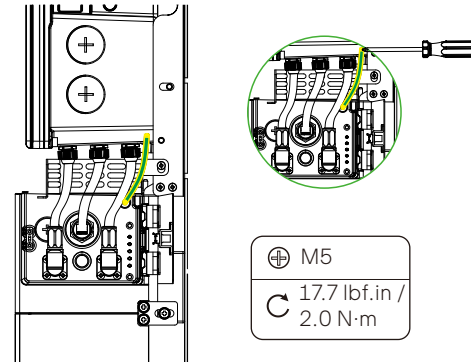

6.4 Communication Connection

All communication cables will be done on the communication board which is in the wiring box.

For the specific requirement of communication cable, please refer to section 6.1 "Overview Of All Electrical Wiring Methods".

6.4.1 Make Communication Connection to Another Inverter/BI

- Inverter communication system diagram

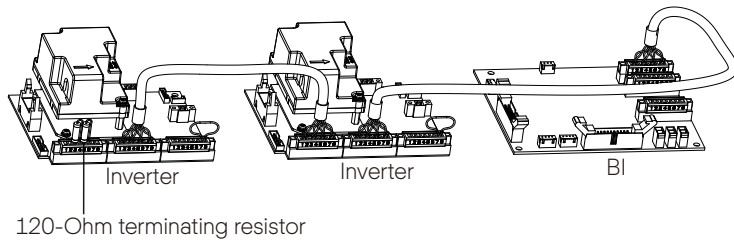

NOTE!

In the first inverter in the communication chain, plug the 8-pin female block with the terminating 120-Ohm resistor into the 8-pin male block. Maximum four inverters can be communicated via communication cable.

- Detailed communication connection diagram

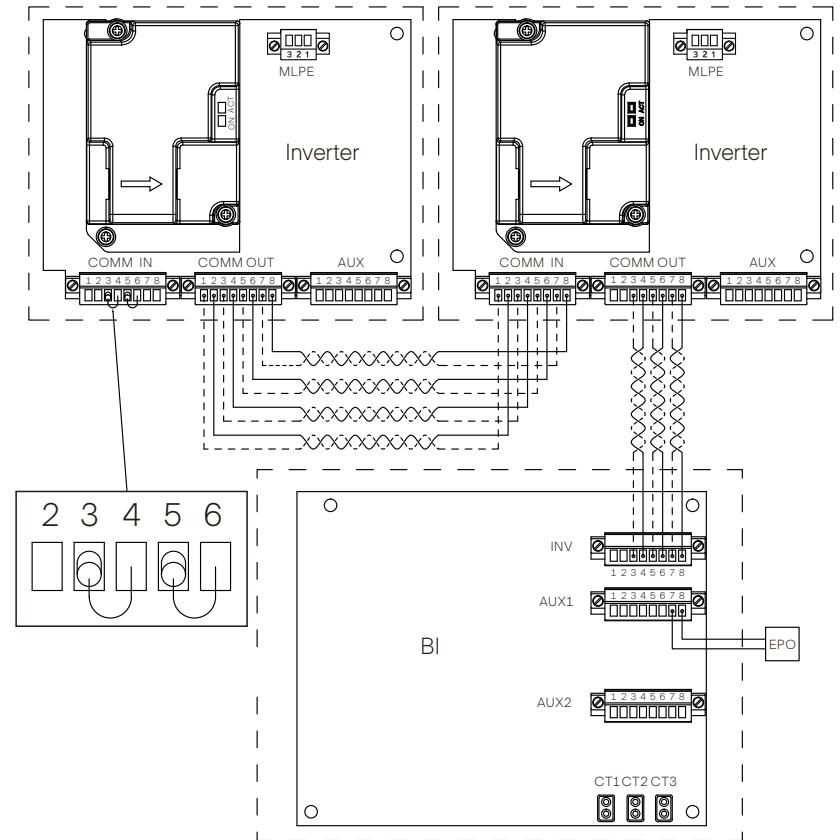

- **Connection steps of terminating resistor**

Step 1: The 120-Ohm resistor has been pre-installed on the 8-pin female block before leaving factory. Take it out from the accessory box.

Step 2: Install the 8-pin female block with resistor to the COMM in male terminal by using slot screwdriver.

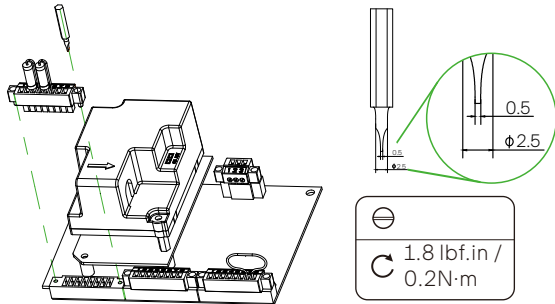

- **Connection steps of communication wire**

Step 1: EHOO-HYBRID series inverter supports to be connected with additional three inverters in maximum. Disassemble 8-pin female blocks from communication board prior to communication connection.

Step 2:

Communication connection between inverters:

Pin 1-Pin 6: Select the CAT5 or better (24-18AWG), use diagonal plier to cut off two wires and leave six wires for connection. Remove 0.24 in / 6 mm of insulation from the end of the six wires.

Pin 7-Pin8: Select two 18-16AWG wires and remove 0.24 in / 6 mm of insulation from the end of the two wires.

Communication connection between inverter and BI:

Pin 3-Pin 6: Select the CAT5 or better (24-18AWG), use diagonal plier to cut off four wires and leave four wires for connection. Remove 0.24 in / 6 mm of insulation from the end of the four wires.

Pin 7-Pin8: Select two 18-16AWG wires and remove 0.24 in / 6 mm of insulation from the end of the two wires.

Step 3: Plug stripped wires into female terminal and ensure that all conductor strands are captured in the terminal.

Step 4: Screw down screw cap tightly.

Step 5:

Connection between inverters:

Plug the female terminal block into the COMM OUT male terminal block on the communication board of the first inverter and screw in each screw tightly. And plug another end of female terminal block into the COMM IN male terminal block on the communication board of the second inverter.

Connection between inverter and BI:

Plug the female terminal block into the COMM OUT male terminal block on the communication board of the inverter and screw in each screw tightly. And plug another end of female terminal block into the INV communication terminal of BI. For the specific communication terminal on the BI, please refer to EHOO-ESS Installation Guide.

Diagram for communication connection steps between inverters

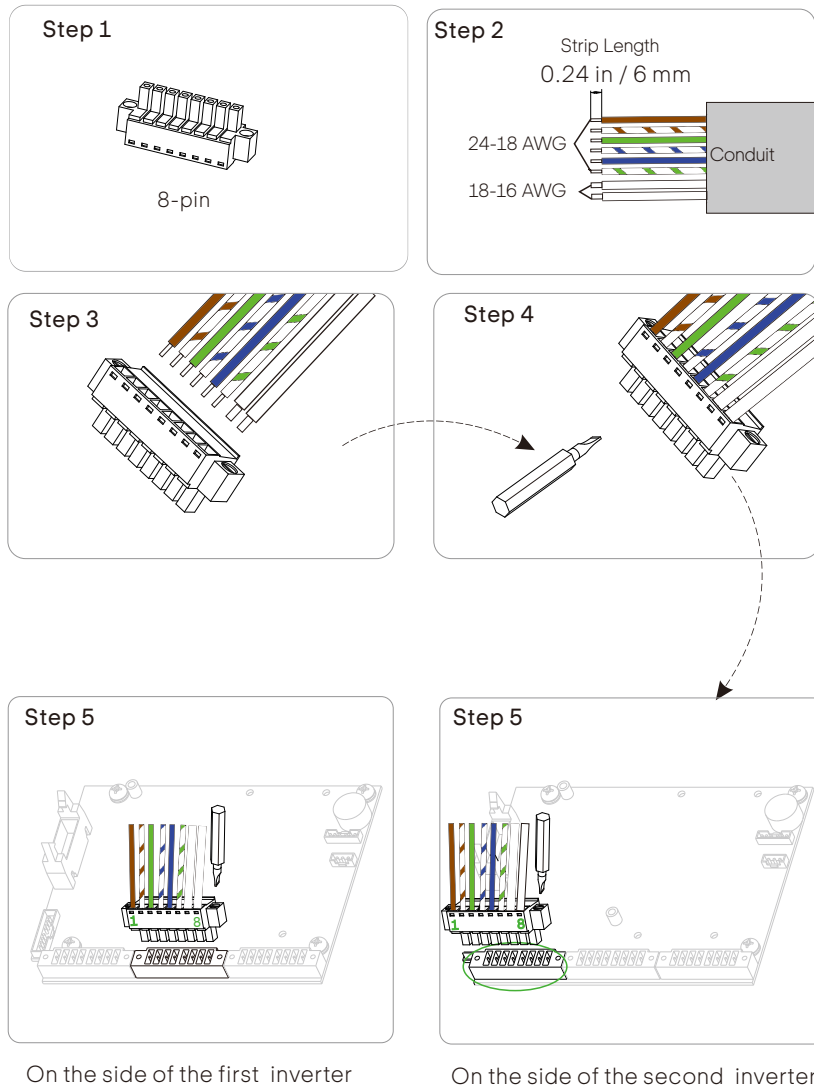
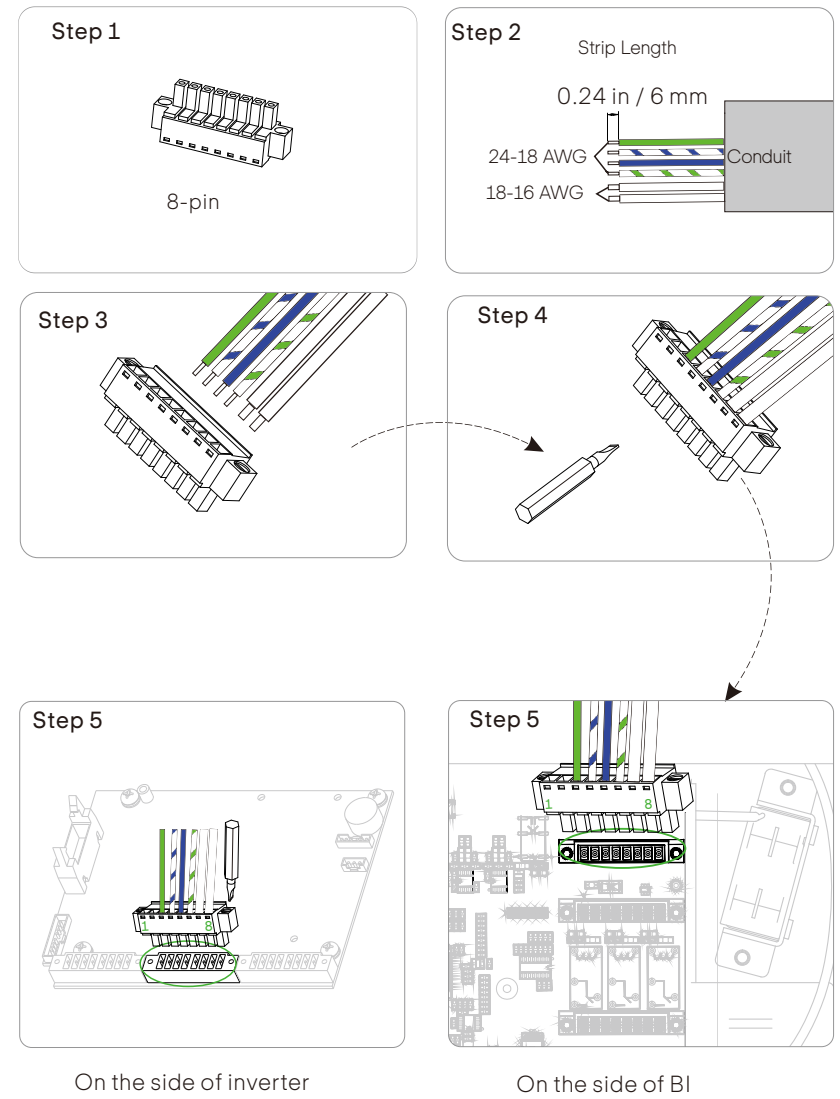

Diagram for communication connection steps between inverter and BI



6.4.2 EPO Connection

Generally, EPO is connected with backup interface to simultaneously command the whole system to become idle and enter a safe mode. While SEMOOKii EHO0-HYBRID series inverter can be wired to include an emergency stop switch as well. EPO connects to inverter only if no backup interface is equipped. Please refer to “Appendix A EPO Connection Steps” for more details.

6.4.3 RGM (Meter X) Connection (Optional)

The RGM (Meter X) is used to get the information about the energy flow. If the Meter X has been purchased from SEMOOKii, it will be pre-mounted inside the inverter before leaving factory.

6.4.4 External Electricity Meter (Meter Y) Connection (Optional)

The external electricity meter (Meter Y) will be integrated in the backup interface if Meter Y has been purchased from SEMOOKii. It connects to inverter only if no backup interface is equipped in the whole system. Please refer to Appendix B Meter Y Connection Diagram for more details about meter connection on the inverter.

6.4.5 RSD Transmitter Connection

The APsmart Rapid Shutdown System Transmitter-PLC-1P is part of a rapid shutdown solution when paired with APsmart signal receiver (RSD-S-PLC-A, RSD-D15-1000 or RSD-D-25-1000), a PV module rapid shutdown unit. While powered on, the Transmitter-PLC-1P sends a signal to the signal receiver to keep their PV modules connected and supplying energy. The signal receiver automatically enter rapid shutdown mode when the Transmitter-PLC-1P is switched off and resume energy production when power is restored to the Transmitter PLC-1P. This solution complies with NEC 690.12 specifications for 2017&2020 and supports the SunSpec signal for rapid shutdown.



NOTE!

The RSD has been integrated in the inverter before leaving factory.



NOTE!

If an emergency stop switch is required, the customer needs to purchase and wire it.

6.4.6 Parallel Connection

The series inverter provides the parallel connection function when connected with Datahub, which could support at most 60 inverters to parallel in one system and can control zero injection to the grid with a meter installed in the main circuit. In this parallel system, the Datahub will be the primary of the system, and all the inverters are the secondaries. The Datahub can communicate with all the secondary inverters.



Note!

The series inverter cannot work in parallel system without Datahub.

Diagram: Parallel system with Datahub

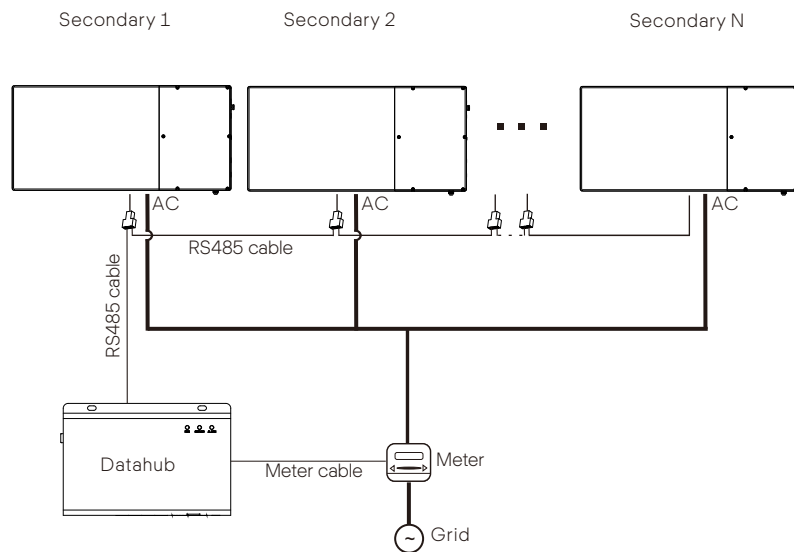

Note!

Before operation, please make sure that the inverters meet the following conditions:

1. All the inverters are recommended to be the same series;
 2. The firmware version of all inverters shall be the same.
- Otherwise, the parallel function cannot be used.

Note!



Before connecting the Datahub to the parallel system, please check that the inverters' settings meet the following conditions:

1. The "Modbus Function" should be "**COM485**".
2. The "ParallelSetting" should be "**Disable**".
3. The addresses of all the inverters in the "RS485 CommAddr" should be **different**. Otherwise, please reset the RS485 communication addresses.

• Wiring operation

- a) Prepare several RJ45 splitters as needed.
- b) Connect one end of an RS485 communication cable with Datahub, and the other end with one of the secondary inverters via a splitter.
- c) Connect all the secondary inverters with each other with RS485 cables via splitters.
- d) Connect the meter with the Datahub and the mains.



Note!

The inverter connected with the Datahub should not enable the "ParallelSetting".

There is no need to set the "ParallelSetting" on the inverters, the parallel system with Datahub will start automatically.

For the details, please refer to the user manual of Datahub.

6.4.7 Monitoring Connection

The inverter is equipped with monitoring port which can collect data and transmit it to monitoring-website via an external monitoring data collector.

SEMOOKii may provide several types of monitoring data collector, such as U WiFi (Optional) and U 4G V4.0-M (Optional). Purchase the product from supplier if needed.

- **Installation instructions**

1) Re-mount the cover of wiring box using Allen key before monitoring connection.

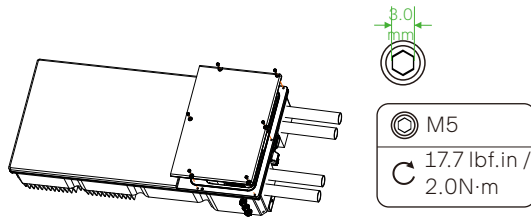

2) Remove the cover of monitoring port and plug the U series module into the port.

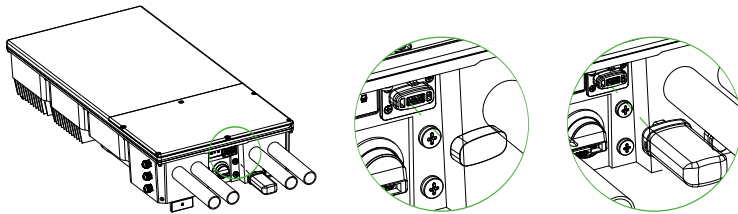

7 Inverter Operation Procedures

7.1 Check Below Steps before Turn on the System

1. Ensure the system is properly mounted.
2. Ensure all grounding wire to the grounding bus-bar are connected properly.
3. Ensure all the communication wirings are connected properly.
4. Ensure all the DC wirings and AC wirings are completed.
5. Ensure the CT is connected properly.
6. Ensure the battery is connected properly.
7. Ensure the loads and critical loads are connected property, and the critical loads rating is within nominal rating range.
8. Ensure the PV arrays are connected properly. Ensure the battery has been turned off, and all the indicator light of the battery are off.

7.2 Turn on the System

1. Before closing any wiring cover, please take photos of the completed wiring in the inverter, battery and BI.
2. Install the wiring box cover of the inverter and secure it firmly with the original screw.
3. Install the internal cover of the BI.
4. Switch on the BI power button (turn to "AUTO").
5. Switch on the AC circuit breakers for the BI and inverter.
6. Make sure that the battery has been turned off, and all the indicator light of the battery are off.
7. Switch on the circuit breaker of battery.
8. Switch on the PV DC switch of the inverter (turn to "ON" position).
9. Press the battery POWER button to start the battery.
10. Install the outer cover of the BI.

The system will start up. Check the status of indicators on inverter, battery and BI for more information on the codes displayed for error and warning messages, refer to section 7.4.

11. Download and configure the APP.

NOTE!



Before you switch on the circuit breaker of the battery, make sure that the battery has been turned off, and all the indicator light of the battery are off. If the battery has been turned on, then you switch on the circuit breaker of the battery, the inverter and the battery may be damaged.

NOTE!
 If the left indicator do not turn green please check the below points:
 All the connections are correct.
 All the external breakers are switched on.
 The DC switch on the inverter is in the "ON" position.







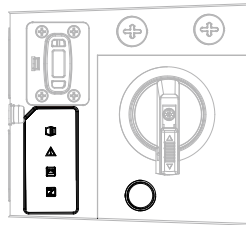

7.3 Shut Down the System

1. If the system is on, press the inverter POWER button for 1 second to turn off the inverter.
2. Switch off the PV DC switch of the inverter (turn to "OFF" position).
3. Press the battery POWER button to turn off the battery.
4. Switch off the circuit breaker of the battery.
5. Switch off the AC circuit breakers for the BI and inverter.

7.4 Definition of indicator light and button





Fault LED 1 and Fault LED 2

-   LED1 flashes green (0.5s on, 0.5s off) and LED2 is red when arc fault occurs. (Arc Detect Fault)
-  LED1 flashes green (2s on, 2s off) and LED2 is red when ground fault occurs. (Isolation Fault)
-  LED1 flashes green (0.5s on, 0.5s off) and LED2 is off when PV voltage fault occurs.(PV Volt Fault)
-  LED1 flashes green (2s on, 2s off) and LED2 is off when Grid error occurs. (GridUnderVoltFault / GridOverVoltFault / GridUnderFreqFault / GridOverFreqFault)
-  LED1 flashes green (0.5s on, 0.5s off) and LED2 flashes red (0.5s on, 0.5s off) when firmware upgrading is ongoing.
-  LED1 is green and LED2 is red when other fault occurs.
-  LED1 is off and LED2 is off when no fault occurs.





Operation LED (Free / Secondary)

-  Green when the inverter is in normal status or in backup status.
-  Flashing green (1s on, 1s off) when the inverter is in waiting or checking status.
-  Off when the inverter has a fault.





Operation LED (Primary)

-  Green for 2s and then quick flashing green for 1s (0.2s on, 0.2s off) when the inverter is in normal or backup status.
-  Flashing green for 2s (1s on, 1s off) and then quick flashing green for 1s (0.2s on, 0.2s off) when the inverter is in waiting or checking status.
-  Off for 2s and quick flashing green for 1s (0.2s on, 0.2s off) when the inverter has a fault.



BAT LED

-  Green when the battery communication is normal and working.
-  Flashing green (1s on, 1s off) when the battery communication is normal and the battery is in idle status.
-  Off when the battery does not communicate with inverter.

All LEDs

All LEDs flash (0.5s on, 0.5s off) when firmware upgrading has been completed but the U drive is still connected.
 All LEDs will be back to the normal state if the U drive is unplugged after the upgrading finished.



Inverter power button

Press the button for 0.5 second: Clear EPS OverLoad Fault / EPS Bat Power Low / BI_TransformerImbalanceHighFault / BI_VoltImbalanceFault / BatBreakOpen Fault.
 Press the button for 1 second: Turn on the inverter if it has been turned off.
 Press the button for 1 second: Turn off the inverter if it has been turned on. The control circuitry remains powered up.
 Press the button for 5 seconds: Run arc self-test if there is no arc fault.
 Press the button for 5 seconds: Clear arc fault if arc fault occurs.

8 Firmware Upgrading

The inverter firmware can be upgraded via a U-disk.

8.1 Preparation

Ensure the inverter is powered on.

The inverter must be connected to the PV panels and the battery must be operating while the firmware upgrade is in progress.

Please prepare a PC and an U-disk.



WARNING!

Make sure the PV input power is more than 150 V (operate the upgrade on a sunny day), otherwise it may result in serious failure during upgrading.

8.2 Upgrading Steps

Step 1. Contact our service support to get the update files, and extract it into your U-disk as follow:

“update\ARM\618.00515.00_EHOO_HYBRID_Manager_V1.87_0427.usb”,
 “update\DSP_Primary\618.00513.00_EHOO_HYBRID_Primary_V1.10_220707.usb”,
 “update\BI\618.00517.00_EHOO_HYBRID_BI_V6.07_0412.usb”;
 “update\BMS_Primary\618.01048_TP001_EHOO-BATTERY-HV-5.0_M_V3.03_20220317.bin”.
 “update\DSP_Secondary\618.00514.00_EHOO_HYBRID_Secondary_V1.58_220613.usb”.

The software version can be found in the “About” display of APP.

Check the software version from the “About” screen as follows by accessing the “Data”-“About” display.

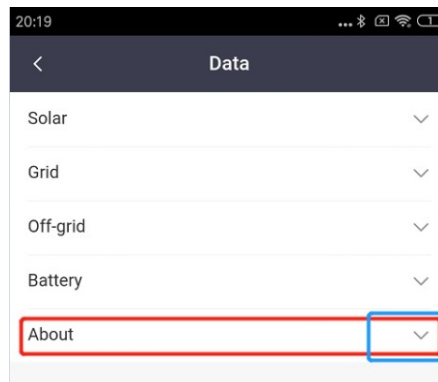

WARNING!

Make sure the directory is in strict accordance with the above form! Do not modify the program file name, or it may cause the inverter to stop running!

Step 2. Switch on the inverter; make sure the operation indicator light is blinking and other indicator lights are off before inserting USB. Then insert the U-disk into the WiFi port on the right side of the inverter.

Step 3. Please refer to Section 7.4 for the indicator status when upgrading and upgrading finished.

Upgrading File	Time Needed for Upgrading
ARM	15-20 S
BI	2.0-2.5 min
BMS_Primary	2.0-2.5 min
DSP_Primary	2.5-3.0 min
DSP_Secondary	1.0-1.5 min

Step 4. Remember to pull out the U-disk.



WARNING!

If upgrading is failed, ensure the inverter is steadily powered on and re-insert the U-disk.

9 Troubleshooting

This section contains information and procedures for solving possible problems with EHOO-HYBRID inverters, and provides you with troubleshooting tips to identify and solve most problems that could occur with EHOO-HYBRID series inverters.

This section will help you narrow down the source of the problems you may encounter. Please read the following troubleshooting steps.

Check warnings or fault messages on the SEMOOKii Cloud. If a message is displayed, record it before doing anything further operation.

Faults	Diagnosis and solution
AFDI Self Check Fault	<p>AFDI Model Self Check Fault</p> <ul style="list-style-type: none"> • Please check if the AFDI module connects normally • Or contact SEMOOKii Technical Support
Arc Detect Fault	<p>DC Arc occurs or DC Arc Check Fault</p> <ul style="list-style-type: none"> • Please check if there is any visible arc vestige firstly • Clear the PV input and solar battery board connects normally • If Arc is detected five times in one hour, please manually clear Arc. Otherwise, it will re-connect to grid in five minutes
PV Conn Dir Fault	<p>PV Reverse Connection Fault</p> <ul style="list-style-type: none"> • Re-connect the PV correctly
BAT Volt Fault	<p>Battery Voltage Over high or Over low Fault</p> <ul style="list-style-type: none"> • Check if the battery input voltage is within the normal range • Please contact SEMOOKii Technical Support
EPO Fault	<p>EPO Activated or Inverter Emergency Off</p>
BI Comm Fault	<p>Communication Fault between Inverter and BI</p> <ul style="list-style-type: none"> • Check if the RS485 communication cable of BI connects to communication board of inverter. • Please contact SEMOOKii Technical Support

Faults	Diagnosis and solution
Update File Fail	<p>File Upgrade Fault</p> <ul style="list-style-type: none"> • Check if the file and the folder are correct • Please contact SEMOOKii Technical Support
Udisk Update Fault	<p>U Disk Upgrade Fault</p> <ul style="list-style-type: none"> • Check if the U disk is correctly plugged and the file is correct • Please contact SEMOOKii Technical Support
Meter Fault	<p>Meter Communication Fault</p> <ul style="list-style-type: none"> • Check if the communication cable between inverter and BI connects normally or contact SEMOOKii Technical Support
BMS_Lost	<p>BMS Communication Lost</p> <ul style="list-style-type: none"> • Check the communication connection between the battery and the inverter • Please contact SEMOOKii Technical Support
Update Fault	<p>Software Upgrade Fault</p> <ul style="list-style-type: none"> • Check if the communication cable between inverter and BI and re-upgrade the software • Check the communication cable between control board and communication board and re-upgrade the software • Check the communication cable between inverter and battery • Or contact SEMOOKii Technical Support
PV Volt Fault	<p>PV Voltage Out of Normal Range</p> <ul style="list-style-type: none"> • Decrease the PV voltage • Or contact SEMOOKii Technical Support
DCI OCP Fault	<p>DCI over current protection Fault</p> <ul style="list-style-type: none"> • Please SEMOOKii Technical Support
DCV OVP Fault	<p>DCV EPS over voltage protection Fault</p> <ul style="list-style-type: none"> • Please SEMOOKii Technical Support
Bat Current Imbalance	<p>The Firmware Fault of Battery Charge</p> <ul style="list-style-type: none"> • Please contact SEMOOKii Technical Support
Bat ConDir Fault	<p>The Positive and Negative Pole of Battery Connected Reversely</p> <ul style="list-style-type: none"> • Re-connect the battery.

Faults	Diagnosis and solution
InvEEPROMFault	Inverter EEPROM Fault <ul style="list-style-type: none"> • Please contact SEMOOKii Technical Support
EPSPowerLow	Battery Power Low in EPS Mode <ul style="list-style-type: none"> • Turn off high power device and charge for the battery
EPS OverLoad Fault	Over Load in EPS Mode. <ul style="list-style-type: none"> • Turn off some device and clear the error
Grid Over Freq Fault	Grid Frequency Out of Range <ul style="list-style-type: none"> • System will reconnect if the utility is back to normal • Or please contact SEMOOKii Technical Support
Grid Over Volt Fault	Grid Voltage Out of Range <ul style="list-style-type: none"> • System will reconnect if the utility is back to normal • Or please contact SEMOOKii Technical Support
Grid Relay Fault	GIRD Relay Fault <ul style="list-style-type: none"> • Please contact SEMOOKii Technical Support
Grid Under Freq Fault	Grid Frequency Out of Range <ul style="list-style-type: none"> • System will reconnect if the utility is back to normal • Or please contact SEMOOKii Technical Support
Grid Under Volt Fault	Grid Voltage Out of Range <ul style="list-style-type: none"> • System will reconnect if the utility is back to normal • Or please contact SEMOOKii Technical Support
Bus Volt Fault	Bus Voltage Out of Normal Range <ul style="list-style-type: none"> • Please contact SEMOOKii Technical Support.

Faults	Diagnosis and solution
Sample Fault	Grid Frequency or Voltage Sample Fault <ul style="list-style-type: none"> • Please SEMOOKii Technical Support
Inter Com Fault	Internal Communication Fault <ul style="list-style-type: none"> • Check the connection between inverter and BI connects normally • Or contact SEMOOKii Technical Support
Isolation Fault	Isolation Fault <ul style="list-style-type: none"> • Check if the insulation of electric wires are damaged or too wet • Or contact SEMOOKii Technical Support
Mgr EEPROM Fault	Manager EEPROM Fault <ul style="list-style-type: none"> • Please contact SEMOOKii Technical Support
Other Device Fault	CPU Self-check Fault or Internal Flash Fault or RAM Fault <ul style="list-style-type: none"> • Please SEMOOKii Technical Support
UnderTemp Fault	Temperature Below the Limitation or Temperature Sensor Fault <ul style="list-style-type: none"> • Please SEMOOKii Technical Support
Over Temp Fault	Temperature over the limitation <ul style="list-style-type: none"> • Check if the environment temperature is over limitation • Check if the internal fan is fault • Or contact SEMOOKii Technical Support
RC OCP Fault	Leakage Current Fault <ul style="list-style-type: none"> • Check if the insulation of electric wires are damaged or too wet • Or contact SEMOOKii Technical Support
Bat Break Open Fault	Battery Break Open Fault <ul style="list-style-type: none"> • Check if the circuit break of battery is open.
Fan Fault	Inverter Internal Fan Fault <ul style="list-style-type: none"> • Please SEMOOKii Technical Support

Faults	Diagnosis and solution
SW OCP Fault	Battery Charge and Discharge Over Current Fault or PV Over Current Fault or Inverter Over Current <ul style="list-style-type: none"> • Please SEMOOKii Technical Support
RCD Fault	Residual Current Device Sensor Fault <ul style="list-style-type: none"> • Please SEMOOKii Technical Support
Rtc Fault	Rtc Fault <ul style="list-style-type: none"> • Please SEMOOKii Technical Support
SoftVerFault	Program Write Fails or Inccorrent Program Written in <ul style="list-style-type: none"> • Re-write the program • Or contact SEMOOKii Technical Support
Grid Lost Fault	Grid Lost Fault <ul style="list-style-type: none"> • System will reconnect if the utility is back to normal • Check if the grid is normal
TZ Protect Fault	The Firmware of PV or Inverter or Battery Over Current Fault <ul style="list-style-type: none"> • Please contact SEMOOKii Technical Support

If the Fault LED is not displaying according to section 7.4 when error occurs, check the following list to make sure that the present state of the installation allows proper operation of the unit.

- Is the inverter located in a clean, dry, adequately ventilated place?
- Have the DC input breakers been opened?
- Are the cables adequately sized and short enough?
- Are the input and output connections and wiring in good condition?
- Are the configurations settings correct for your particular installation?
- Are the communications cable properly connected and undamaged?

Contact the SEMOOKii customer support for further assistance. Be prepared to describe details of your system installation and provide model and serial number of the unit.

10 Maintenance

Inverters do not need any maintenance or correction in most condition, but if the inverter often loses power due to overheating, the cooling fans on the rear of house may be covered by dirt.

Clean the cooling fans with a soft dry cloth or brush if necessary.

Only trained and authorized professional personnel who are familiar with the requirements of safety should perform servicing and maintenance work.

➤ Safety checks

Safety checks should be performed at least every 12 months. Please contact the manufacturer (SEMOKKii) to arrange a qualified person with adequate training, knowledge, and practical experience to perform these tests. (Note: this action is not covered by warranty). The data should be recorded in an equipment log. If the device is not functioning properly or fails any test, the device has to be repaired. For safety check details, refer to Section 2 Safety instruction of this manual.

➤ Recommended Periodic Maintenance

Only qualified people should perform the following tasks.

While using the inverter, the user should examine the machine regularly:

- Check if the indicators of the inverter are in normal state, check if the keys of the inverter are in normal state. This check should be performed at least every 6 months.
- Check that if the input and output wires are damaged or aged. This check should be performed at least every 6 months.

For DC Switch, the user should:

- 1. Check the installation for signs of overload, overheating, and that the terminals do not exceed the limit of 167°F/75°C under full load.
- By operating the switch a few times (5x), the contacts will clean themselves and the switch will have a longer life.

11 Decommissioning

11.1 Remove the Inverter

1. Disconnect the inverter from DC Input, AC output, BI and battery.
2. Wait for 5 minutes for de-energizing.
3. Disconnect communication and optional connection wires.
4. Remove the inverter from the wall bracket.
5. Remove the bracket if necessary.

11.2 Packaging

If possible, always pack the inverter in its original carton and secure it with tension belts. If the original package is no longer available, you can also use an equivalent carton that meets the following requirements;

- Suitable for the weight of product.
- Easy to carry.
- Be capable of being closed completely

11.3 Storage and Transportation

Store the inverter in a dry environment where ambient temperature stays between -13°F/-25°C ~ 167°F/75°C. Take care of the inverter during the storage and transportation, keep less than 5 cartons in one stack.

11.4 Disposal of Inverter

Do not dispose of faulty inverters or accessories together with household waste. Please accordance with the disposal regulations for electronic waste which is applied at the installation site at that time.

12 Disclaimer

The inverters shall be transported, used and operated under restricted conditions. SEMOOKii will not provide any service, technical support or compensation in case of the following circumstances, including but not limited to:

- The inverter is damaged by force majeure (such as earthquake, flooding, thunderstorm, lighting, fire hazard, volcanic eruption, etc.);
- The inverter's warranty is expired, but not extended;
- The inverter's SN, warranty card or invoice cannot be provided;
- The inverter is damaged by man-made cause;
- The inverter is used or operated against any items in local policy;
- The installation, configuration and commissioning of the inverter doesn't meet the requirements mentioned in this manual;
- The inverter is installed, refitted or operated in improper ways;
- The inverter is installed, operated under improper environment or electrical condition;
- The inverter is changed, updated or disassembled on hardware or software without authority from SEMOOKii;
- The communication protocol from other illegal channels is used; and
- The monitoring or control system is used without authority from SEMOOKii.

SEMOOKii reserves the right for the final explanation.

Appendix A EPO Connection Steps

For installing EPO on the inverter, follow the below installation instructions.

Step 1: Remove the factory-installed jumper from Pin 7 and 8 of the 8-position “AUX” connector inside the inverter.

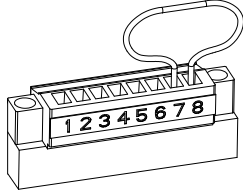

Step 2: Use minimum 24 AWG conductors to connect Pin 7 and Pin 8 (labeled “12V” and “STOP_NO”) to a suitable emergency stop switch.

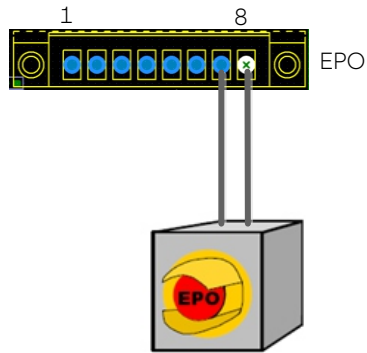

Appendix B Meter Y Connection Diagram

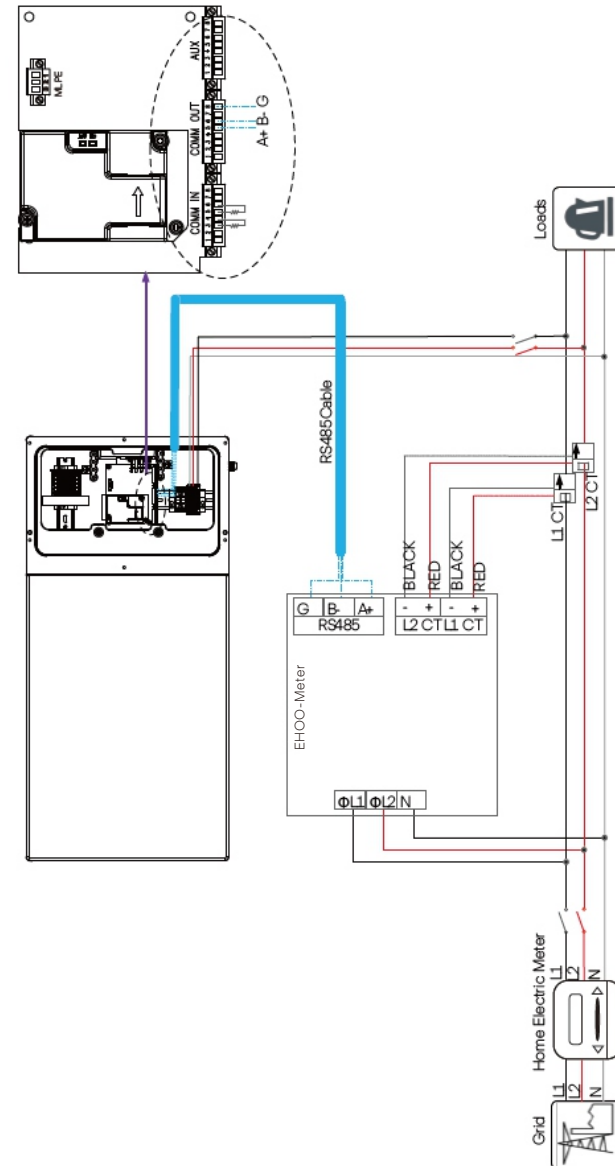

1 Whole home backup solution (Parallel operation)-with standalone meter

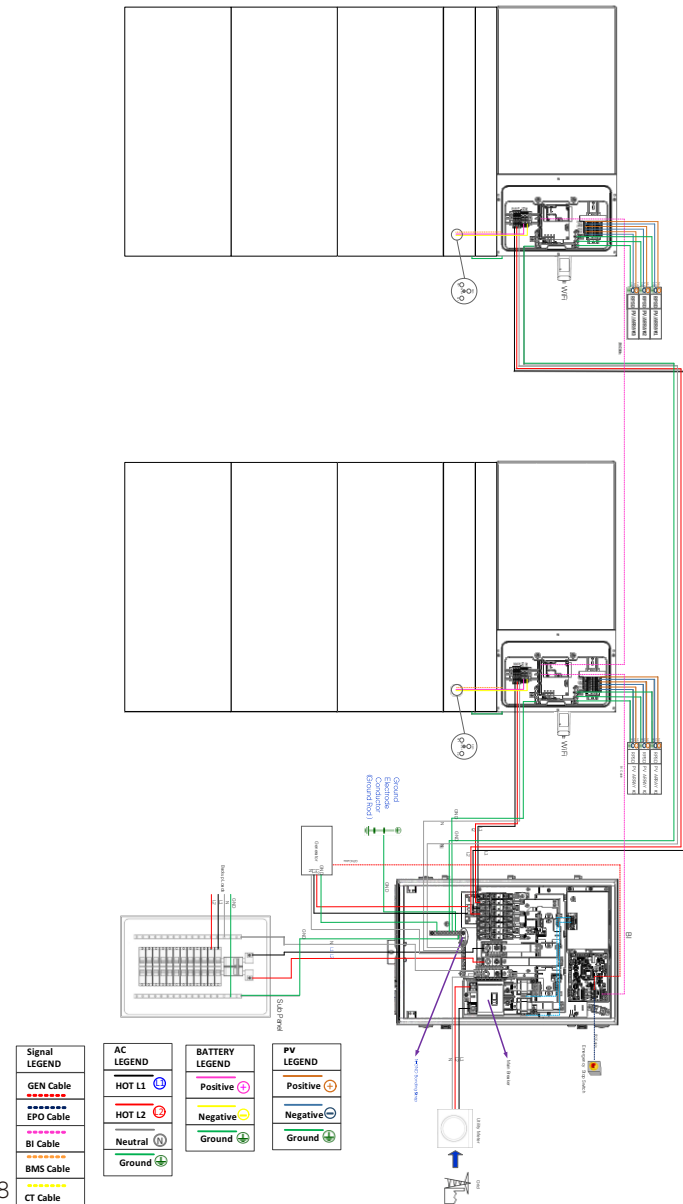

2 Partial home backup solution (Parallel operation) -with meter load center

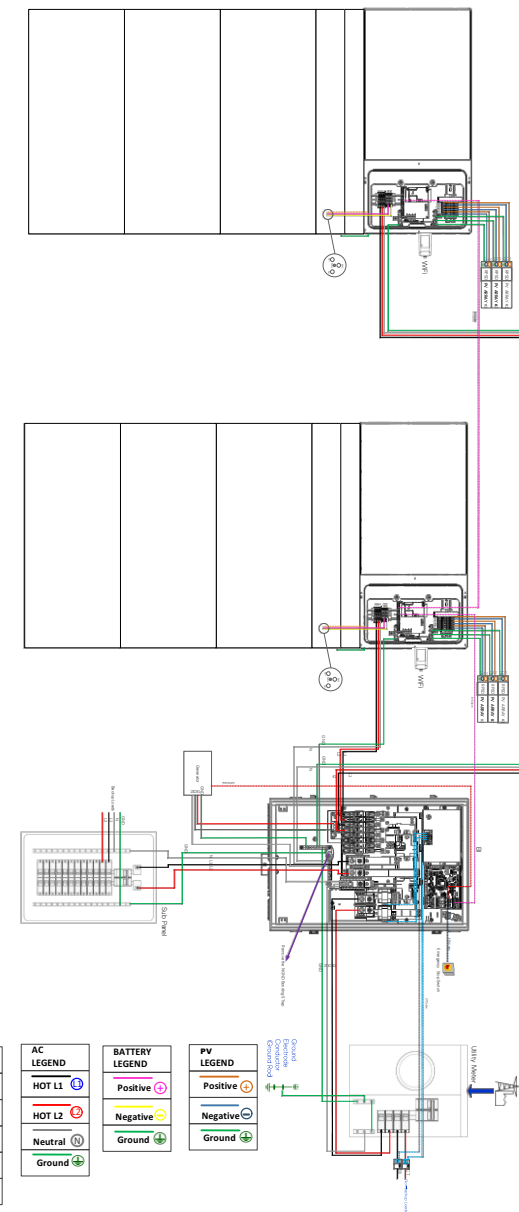

3 Whole home backup solution-with standalone meter

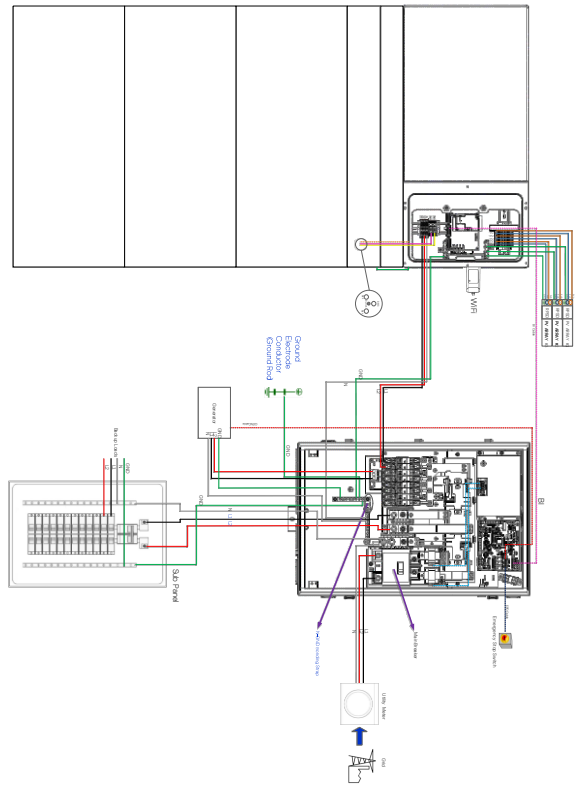

Signal LEGEND	AC LEGEND	BATTERY LEGEND	PV LEGEND
GEN Cable	HOT L1	Positive	Positive
EPO Cable	HOT L2	Negative	Negative
BI Cable	Neutral	Ground	Ground
BMS Cable	Ground		
CT Cable			

4 Partial home backup solution -with meter load center

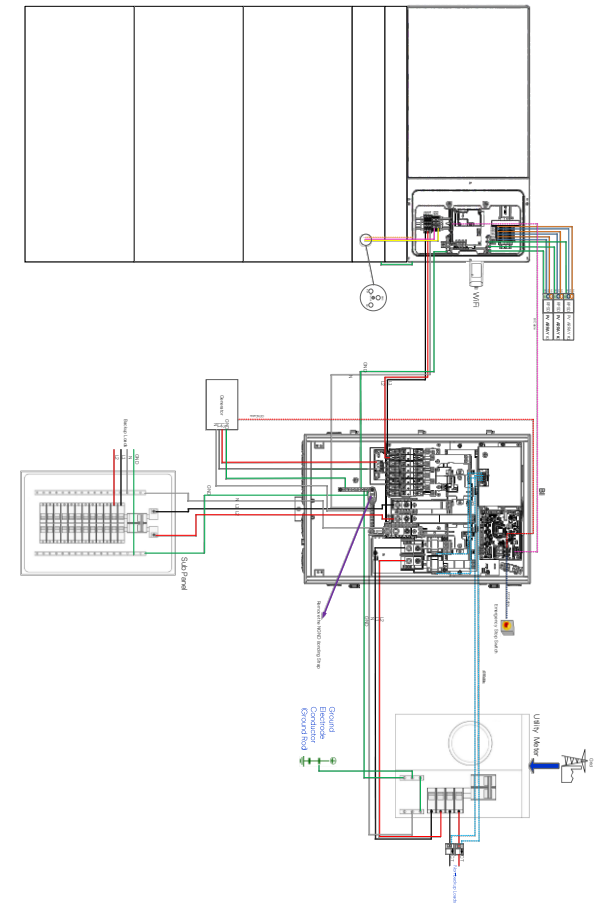

Signal LEGEND	AC LEGEND	BATTERY LEGEND	PV LEGEND
GEN Cable	HOT L1	Positive	Positive
EPO Cable	HOT L2	Negative	Negative
BI Cable	Neutral	Ground	Ground
BMS Cable	Ground		
CT Cable			

5 Partial home backup solution

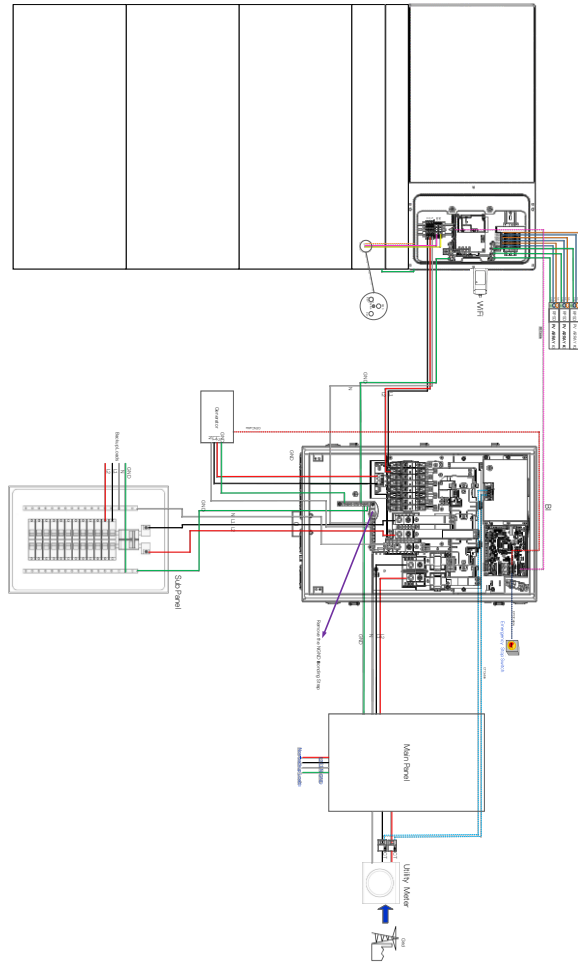

Signal LEGEND	AC LEGEND	BATTERY LEGEND	PV LEGEND
GEN Cable	HOT L1	Positive	Positive
EPO Cable	HOT L2	Negative	Negative
BI Cable	Neutral	Ground	Ground
BMS Cable	Ground		
CT Cable			

6 Partial home backup solution-with meter load center & microgrid system

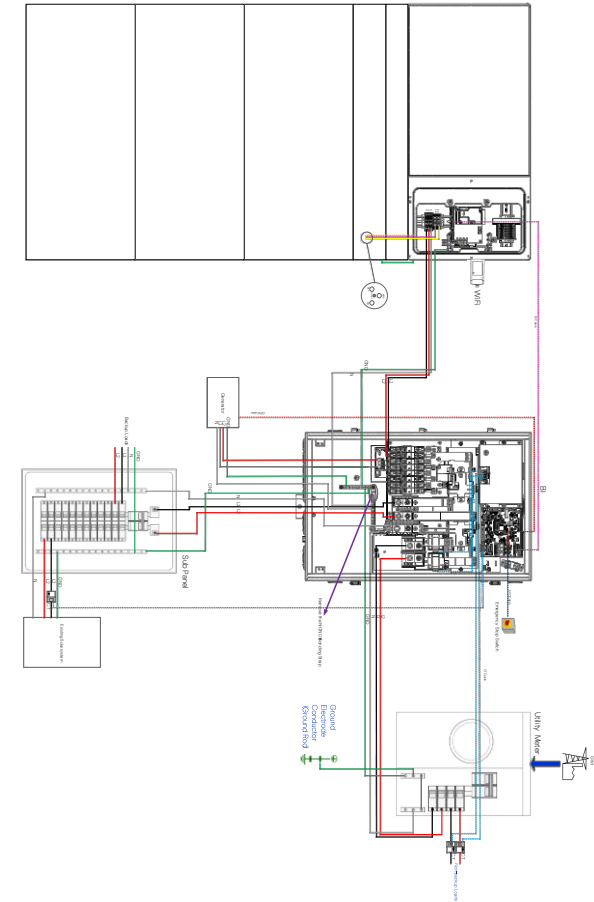

Signal LEGEND	AC LEGEND	BATTERY LEGEND	PV LEGEND
GEN Cable	HOT L1	Positive	Positive
EPO Cable	HOT L2	Negative	Negative
BI Cable	Neutral	Ground	Ground
BMS Cable	Ground		
CT Cable			

7 Partial backup solution & microgrid system

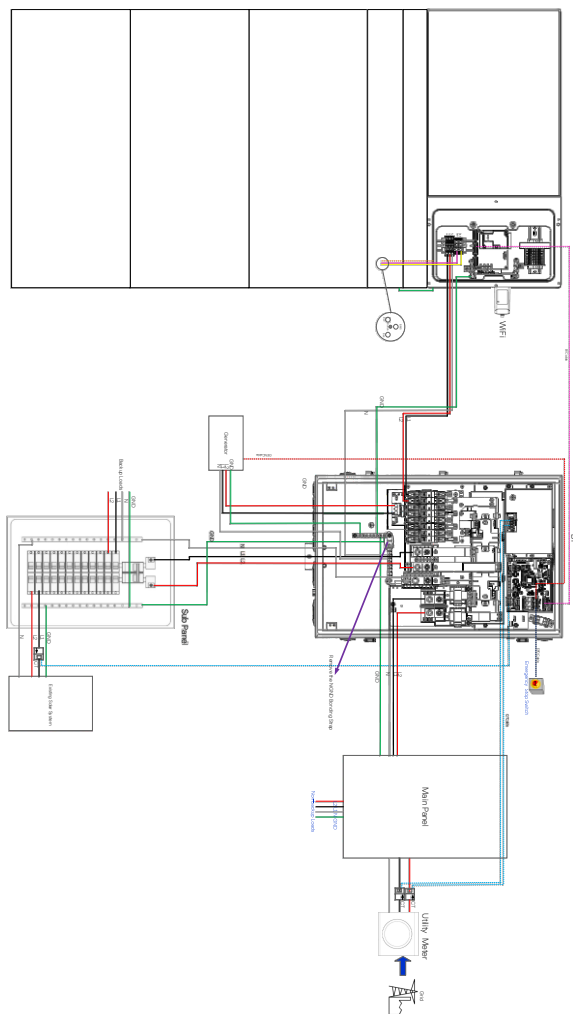

Signal LEGEND	AC LEGEND	BATTERY LEGEND	PV LEGEND
GEN Cable -----	HOT L1 ⚡	Positive ⊕	Positive ⊕
EPO Cable -----	HOT L2 ⚡	Negative ⊖	Negative ⊖
BI Cable -----	Neutral Ⓝ	Ground ⊕	Ground ⊕
BMS Cable -----	Ground ⊕		
CT Cable -----			

Warranty Registration Form



For Customer (Compulsory)

Name Country

Phone Number Email

Address

State Zip Code

Product Serial Number

Date of Commissioning

Installation Company Name

Installer Name Electrician License No.

For Installer

Module (If Any)

Module Brand

Module Size(W)

Number of String Number of Panel Per String

Battery (If Any)

Battery Type

Brand

Number of Battery Attached

Date of Delivery Signature

Please visit our warranty website: www.semookii-ehoo.com to complete the online warranty registration.

For more detailed warranty terms, please visit SEMOOKii official website: www.semookii.com to check it.

