

opk SPACESHIP



≥580mm



W 35-45mm
G 8-10mm



Bau Systeme
Building systems

opk Spaceship W Deckenmontage / Ceiling Mounting



Technische Zeichnung Technical drawing

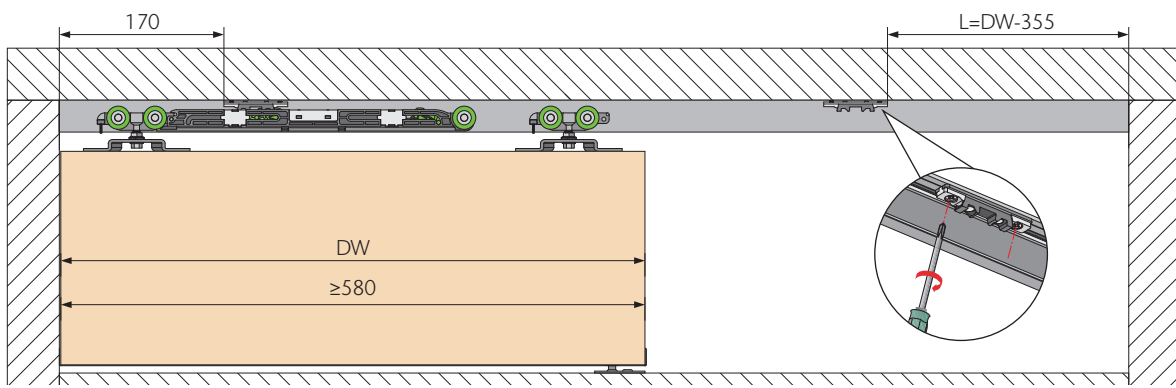
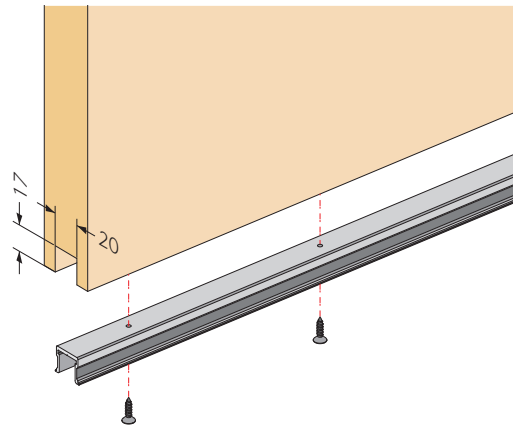
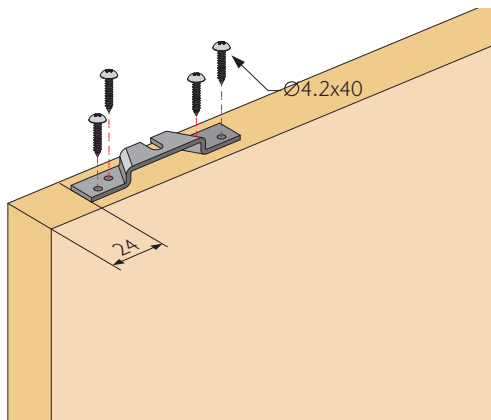
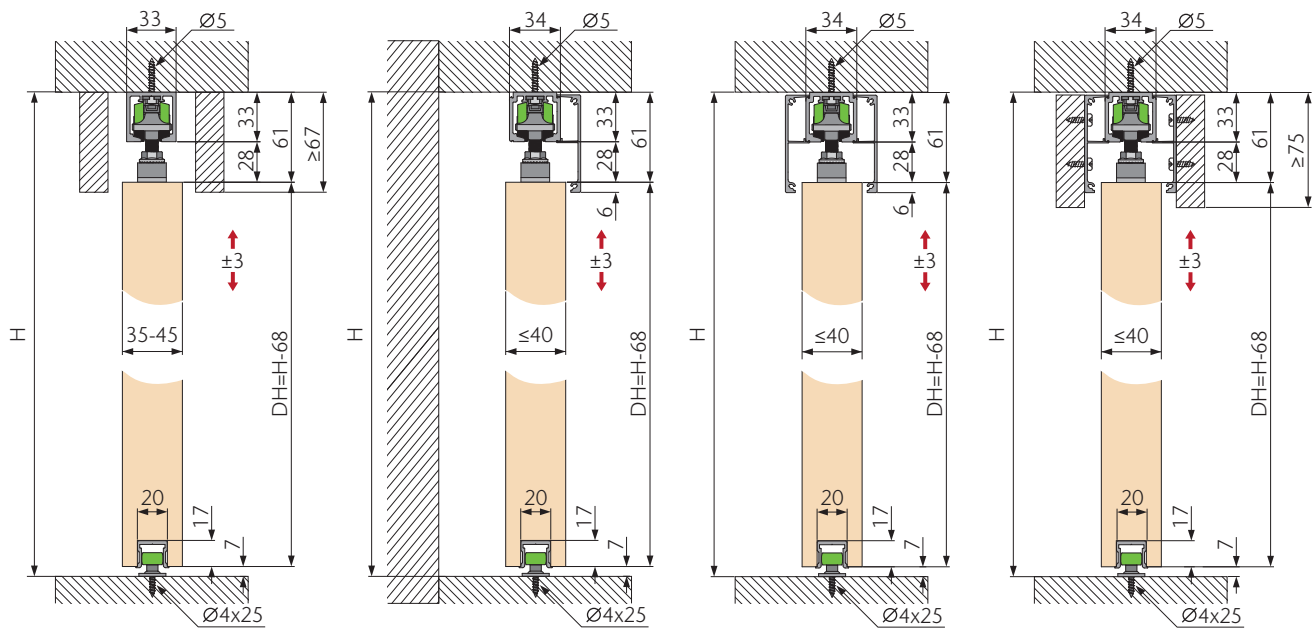

opk Spaceship W Deckenmontage / Ceiling Mounting



Art.-Nr./No.

		≤80	≥580	03-011-103-200
--	--	-----	------	----------------

Konfiguration für 1 Tür

Configuration for 1 door



Laufwerk 2-Wege Dämpfer <i>Running part with two-way damper</i>		1
Laufwerk <i>Running part (roller)</i>		1
Aktivator <i>Activator</i>		2
Aufhängung Holz <i>Suspension bracket wood</i>		2
Bodenführung 1 Rolle Holz <i>Floor guide 1 roller wood</i>		1
Endkappe Führungsschiene <i>Cover cap guiding track</i>		2
Zubehörset Holz <i>Accessories wood</i>		1

opk Spaceship W Ceiling Mounting Kit (incl. running and guiding track)











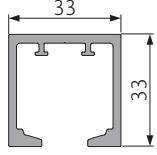

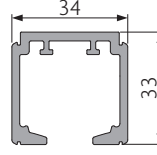

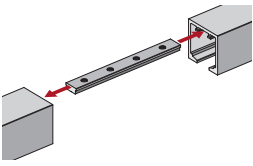
Kit Art.-Nr./No.	03-011-102-E20	QTY	
Laufschiene 33 mm (2050mm) <i>Running track (2050mm)</i>		1	
Führungsschiene Holz (1250mm) <i>Guiding track wood (1250mm)</i>		1	
Konfiguration für 1 Tür <i>Configuration for 1 door (whole set fittings of 03-011-103-200)</i>		1	

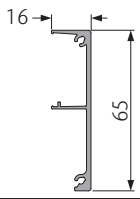
opk Spaceship W/G Deckenmontage / Ceiling Mounting

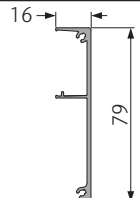
Schienen, Zubehör

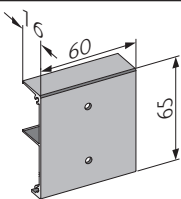
Tracks, Accessories

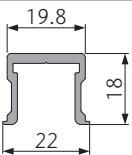

Produktbeschreibung Description		Material Material	Farbe Finish	Länge Length (mm)	Art.-Nr./No.
Laufschiene 33 mm Running track  	Aluminium eloxiert Anodized aluminium	Silber Silver	2050	03-016-252-E20	
			2500	03-016-252-E25	
			3500	03-016-252-E35	
			5800	03-016-252-E58	
Laufschiene clip-in Blende Running track click in cover  	Aluminium eloxiert Anodized aluminium	Silber Silver	2050	03-016-252-H20	
			2500	03-016-252-H25	
			3500	03-016-252-H35	
			5800	03-016-252-H58	
Verbinder Laufschiene Connecting bracket  	Aluminium Aluminium	Roh Raw	100	03-015-000-400	
Blende 65 mm Decorative cover  	Aluminium eloxiert Anodized aluminium	Silber Silver	2050	03-016-25A-020	
			2500	03-016-25A-025	
			3500	03-016-25A-035	
			5800	03-016-25A-058	
Blende 79 mm Decorative cover  	Aluminium eloxiert Anodized aluminium	Silber Silver	2050	03-016-25B-020	
			2500	03-016-25B-025	
			3500	03-016-25B-035	
			5800	03-016-25B-058	
Halterung Holzblende Bracket wood cover  	Aluminium eloxiert Anodized aluminium	Silber Silver	60	03-016-25D-000	
Führungsschiene Holz Guiding track wood  	Aluminium Aluminium	Roh Raw	1250	03-017-100-012	
			2500	03-017-100-025	
Endkappe Laufschiene 33 Cover cap running track 33 	Kunststoff Plastic	Schwarz Black	1 Set	03-016-30C-E00	